

# Artemide®

## Vigo Lettura

design  
D. Chipperfield

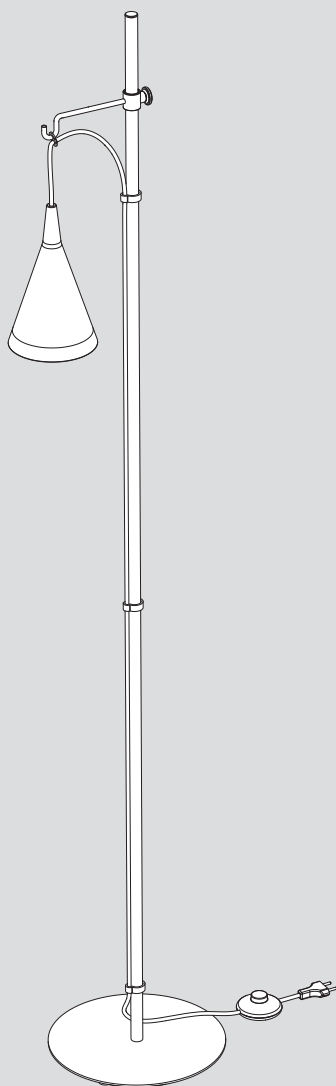



i

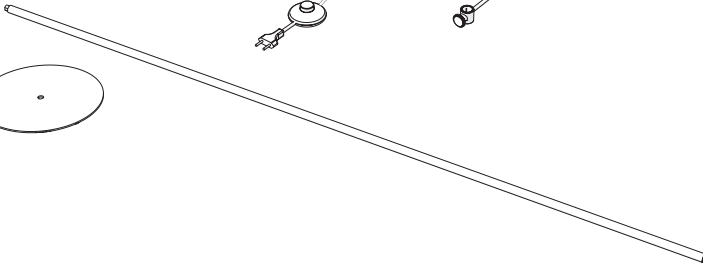
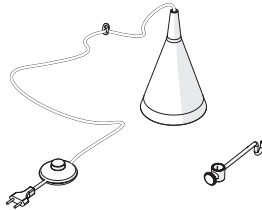
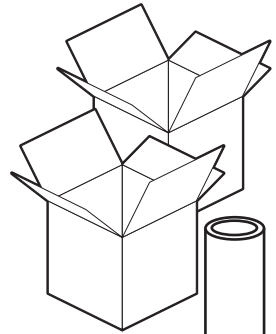
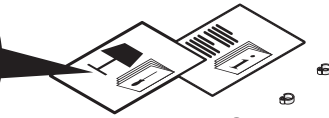
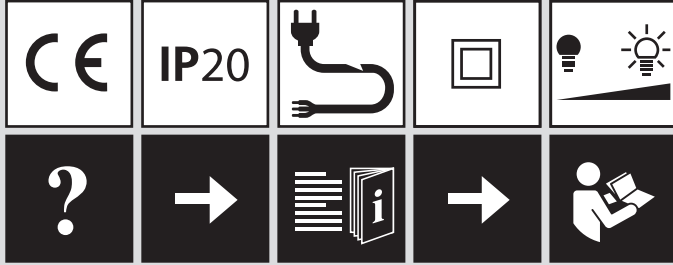

1

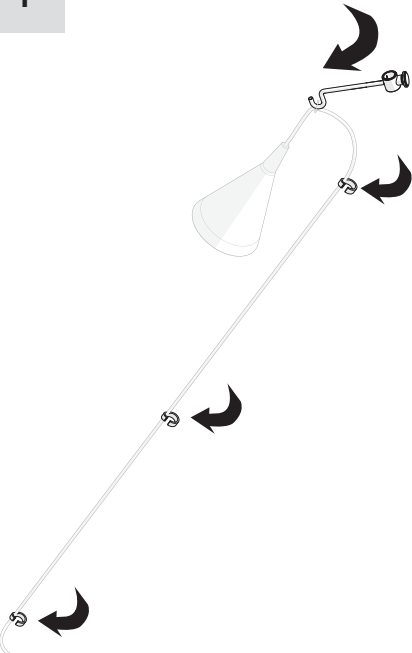

2

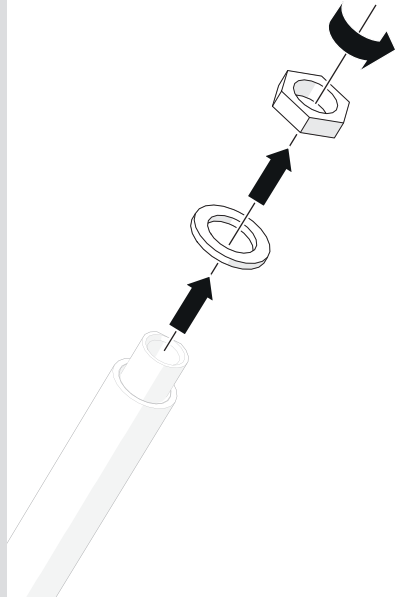

3



4

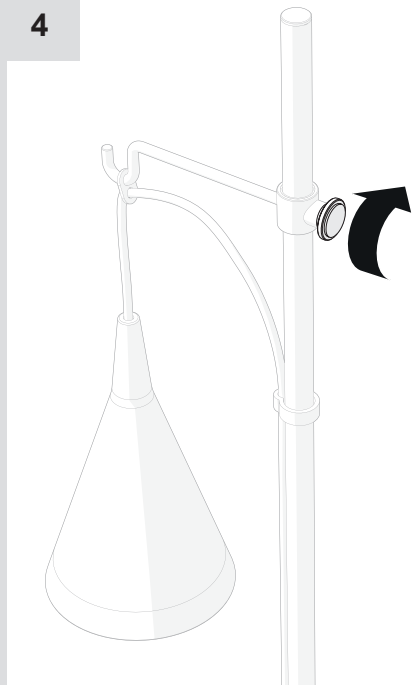

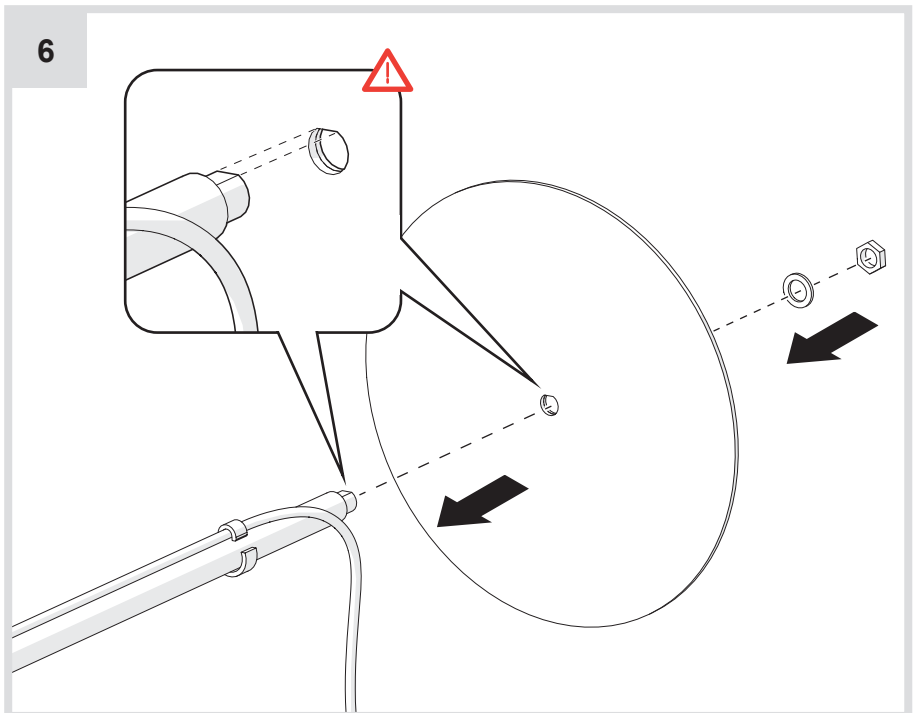
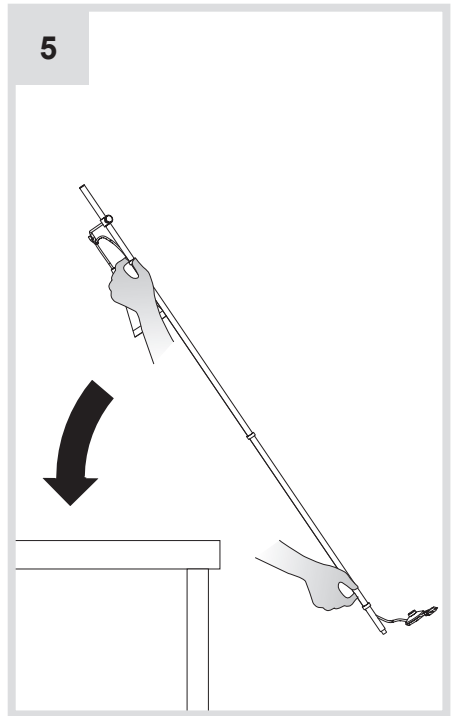
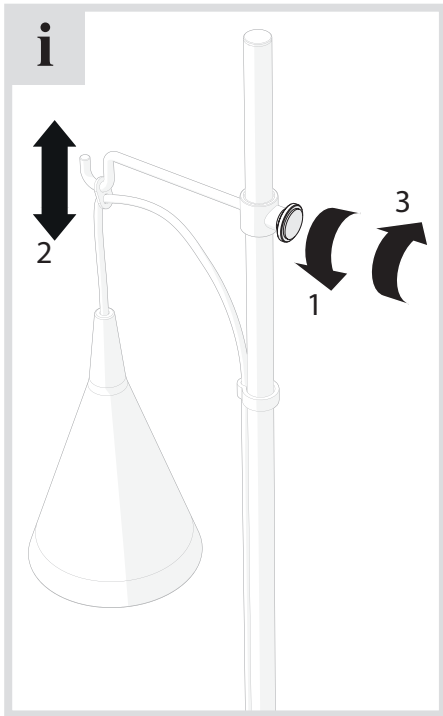

7

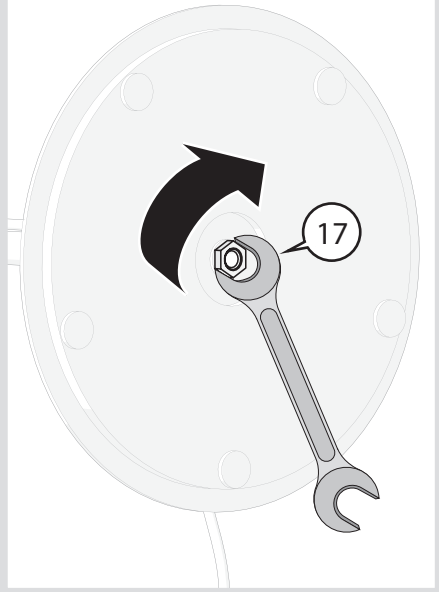

8

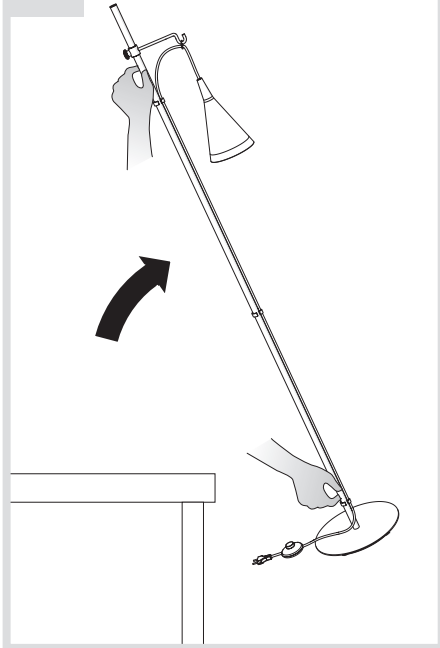

9

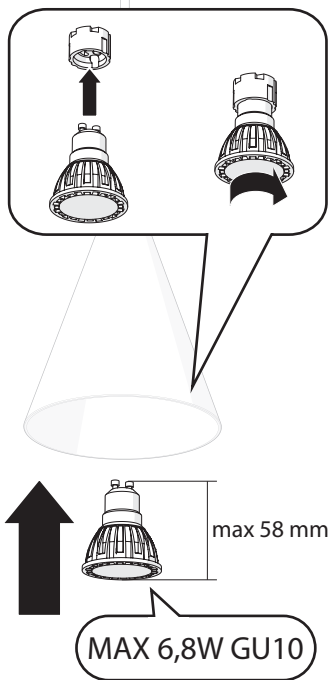

10

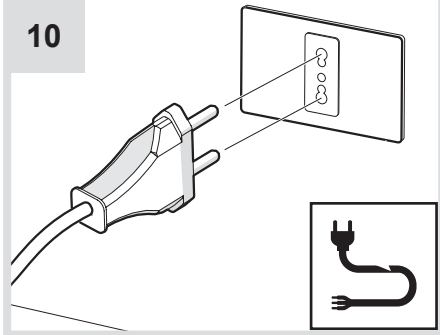

11

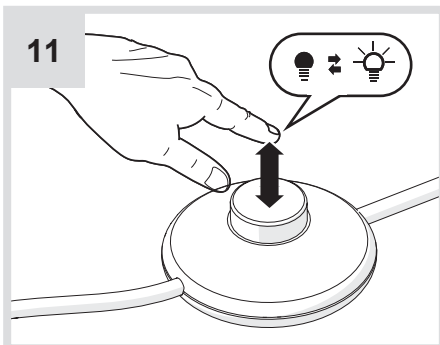

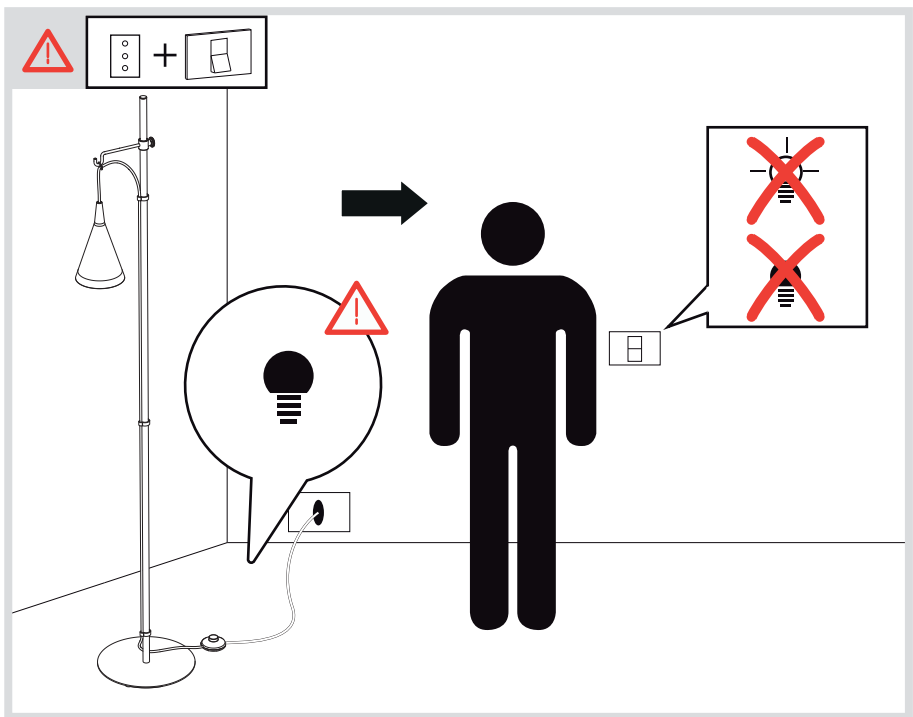
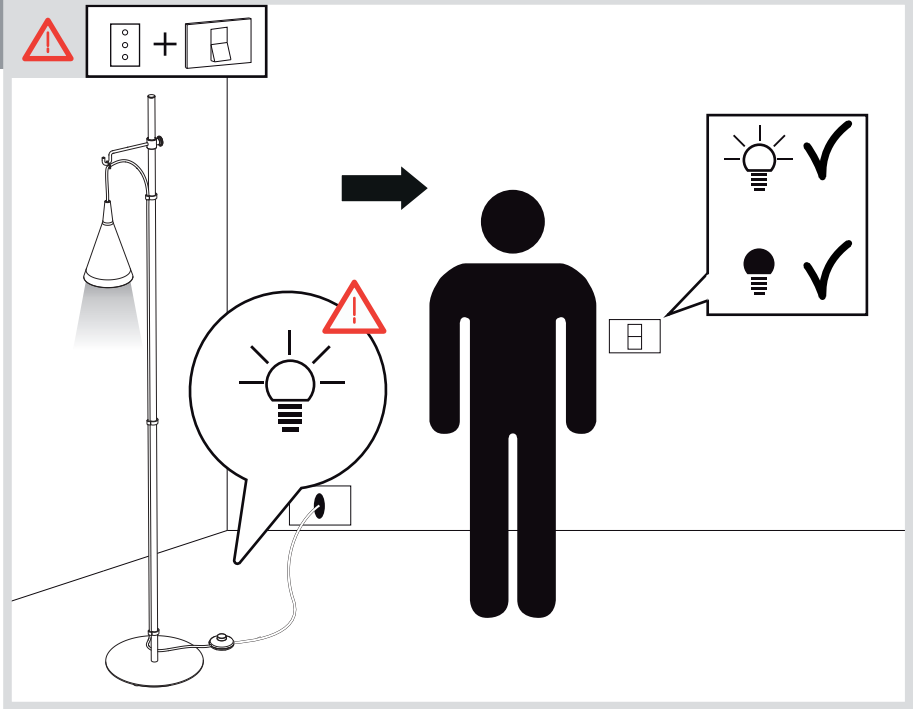

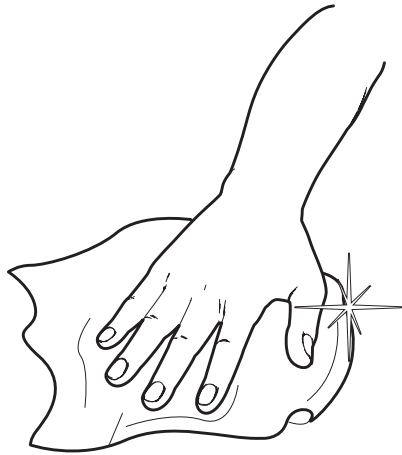
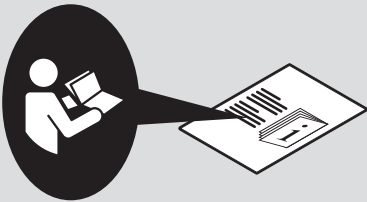
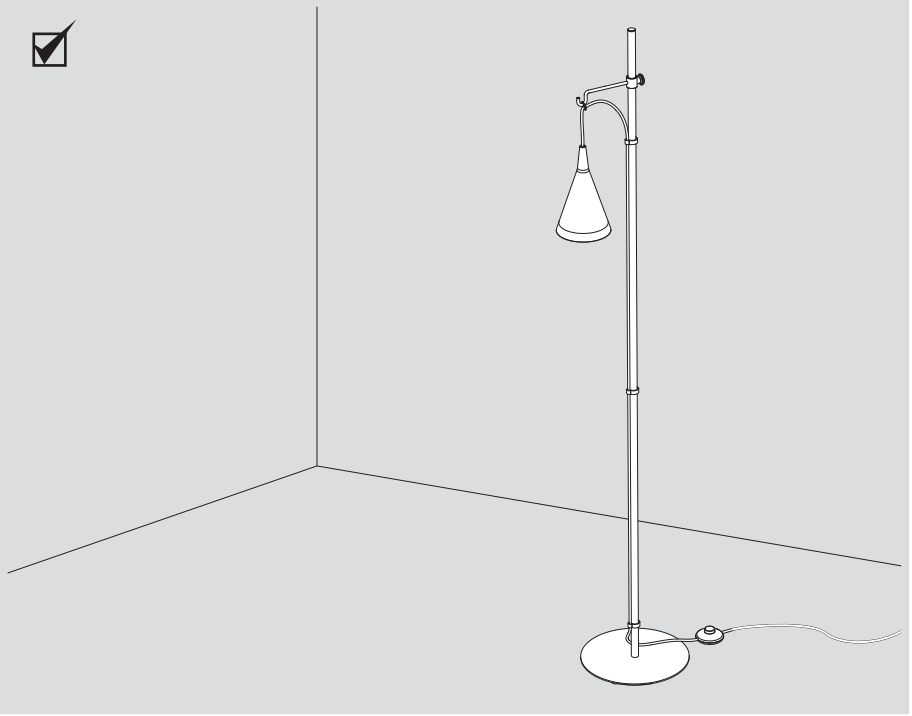

**Artemide®**



**Artemide**

via Bergamo, 18  
20010 Pregnana M.se (MI)  
ITALIA

tel. +39 02 935 181  
fax +39 02 935 90 254  
fax +39 02 935 90 496

[www.artemide.com](http://www.artemide.com)

VAT IT00846890150

cod. Y513000405