

## Sito verticale VOLT datasheet

LED wall spotlight for exterior with spherical head and double-sided light output (up/down vertical). The lighting effect can be decided upon purchase.

The wall spotlight complies with protection class IP65 and is thus dust-tight and jet-proof. Version for surface mounting, connection to 230V (AC) mains voltage (VOLT light engine), dimmable via trailing-edge phase-cut dimmer\*.

Other versions: Sito giro, Sito lato (ceiling luminaire), Sito giù, Sito lato (wall luminaire), Sito basso (floor luminaire), Sito palo (bollard)

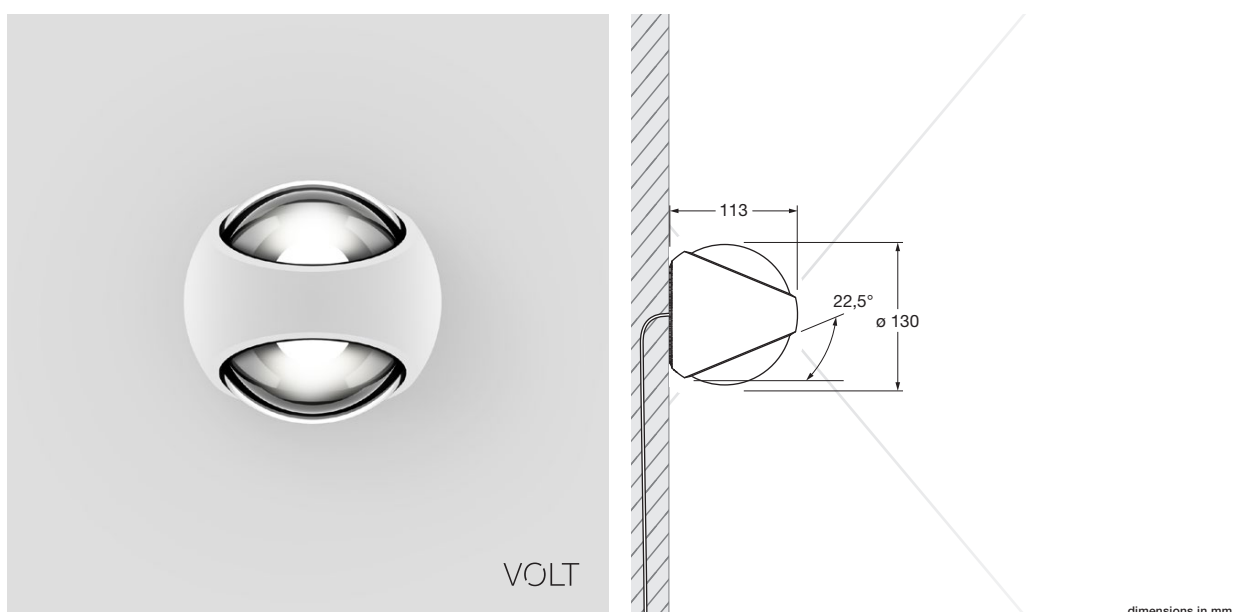

### technical data Sito verticale VOLT

properties	material	aluminium, painted, optical glass
	weight	1.3 kg
surface	head	matt white, glossy white, matt black
	VOLT light engine	
	average life time	> 40.000 hrs
	energy efficiency class	A
	power	2 x 9 W
	color rendering index	perfect color; CRI Ra 97
	color temperature	2700 K, 3000 K
	recommended use	exterior and damp room
electricity	dimming	by trailing-edge phasecut dimmer*
	connection	230 V AC / 50 Hz
	permitted operating conditions	-20°C to +40°C

\* For a list of compatible dimmers, see [www.occhio.de/dim\\_en](http://www.occhio.de/dim_en)



## Sito verticale VOLT lighting effects

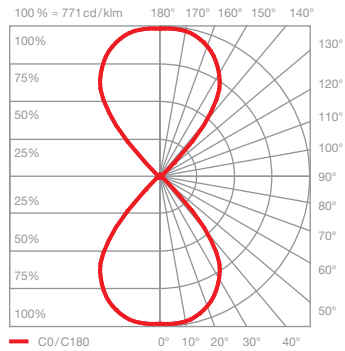
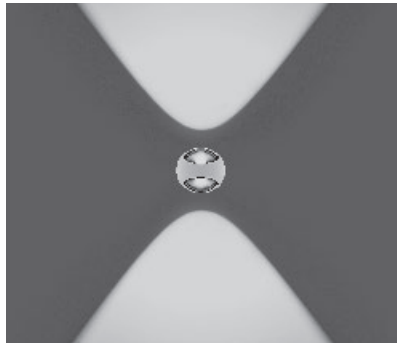

### C80 contour

scattered light with contour beam angle  
(approx. 80°)

inserts:        spherical glass  
                  small lens high

luminous flux: perfect color        2 × 9W 1100lm

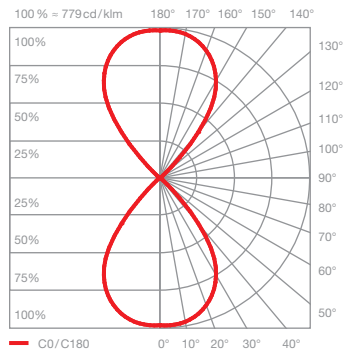
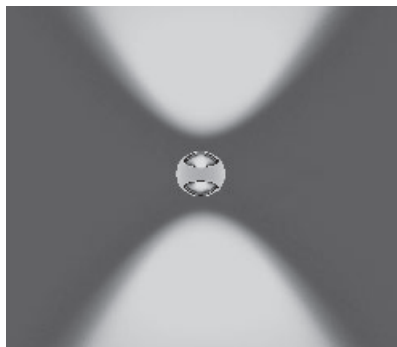

### S80 soft

scattered light with soft contour beam angle  
(approx. 80°)

inserts:        spherical glass  
                  small lens high  
                  soft edge glass

luminous flux: perfect color        2 × 9W 980lm

## Sito verticale VOLT connect several luminaires

through-wired with buried exterior  
junction box

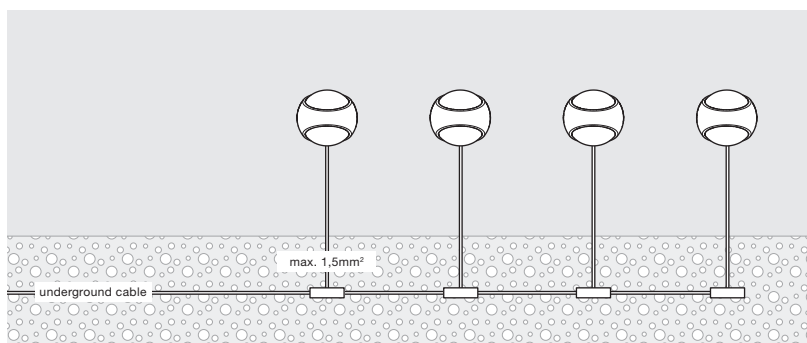

through-wired with plug in terminals

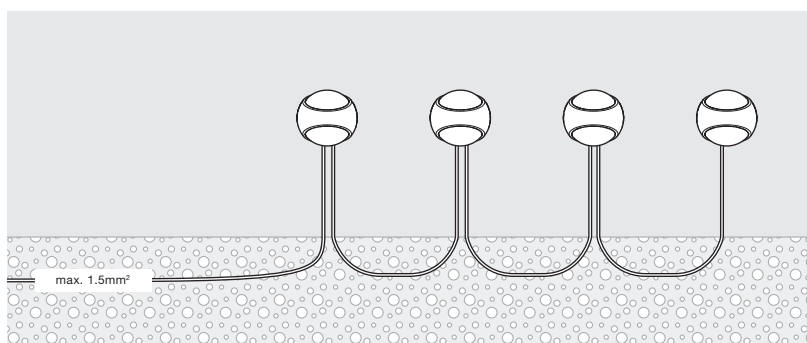

Occhio air module in switch box or  
distribution box



max. 4 luminaires

