

Sito palo VOLT datasheet

LED bollard for exterior with spherical head (adjustable up to 45° to the left and right) and single-sided light output (45°). Available either with spherical glass (Sito) or flat glass (Sito R) with internal lens, the lighting effect can be decided upon purchase.

The luminaire complies with protection class IP65 and is thus dust-tight and jet-proof. Thanks to the optional ground anchoring, it can be also mounted on loose ground. Connection to 230 V (AC) mains voltage; dimmable via trailing-edge phase-cut dimmer*.

Other versions: Sito giro, Sito lato (ceiling luminaire), Sito verticale, Sito giù, Sito lato (wall luminaire), Sito basso (floor luminaire)

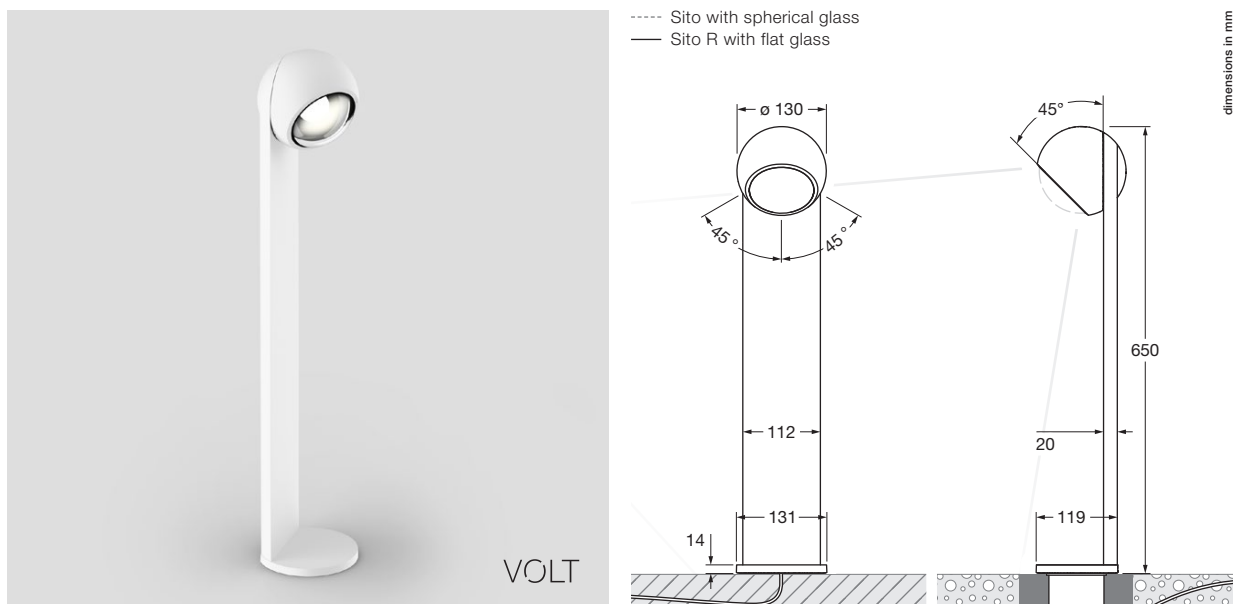

technical data Sito palo VOLT

properties	material	aluminium, painted, optical glass
	movability head	45° (with stop and fixable)
	weight	3.0 kg (ground anchor 2.3 kg)
surface	head	matt white, glossy white, matt black
	body	matt white, matt black
VOLT light engine	average life time	> 40.000 hrs
	energy efficiency class	A
	power	18 W
	color rendering index	perfect color; CRI Ra 97
	color temperature	2700 K, 3000 K
	recommended use	exterior and damp room
electricity	dimming	by trailing-edge phasecut dimmer *
	connection	230 V AC / 50 Hz
	permitted operating conditions	-20°C to +40°C

* For a list of compatible dimmers, see www.occhio.de/dim_en



Sito palo VOLT Sito lighting effects

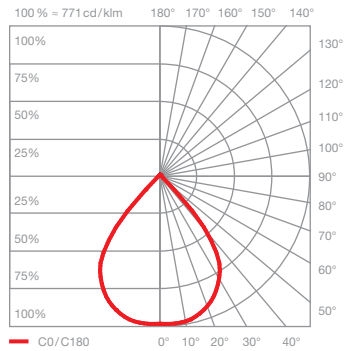

C80 contour

scattered light with contour beam angle
(approx. 80°)

inserts: spherical glass
small lens medium

luminous flux: perfect color 18W 1100lm

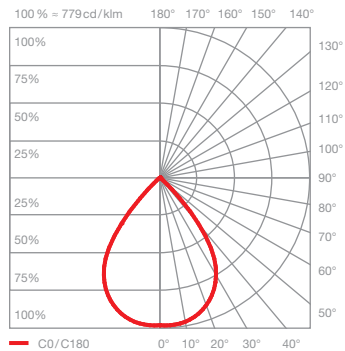

S80 soft

scattered light with soft contour beam angle
(approx. 80°)

inserts: spherical glass
small lens medium
soft edge glass

luminous flux: perfect color 18W 980lm

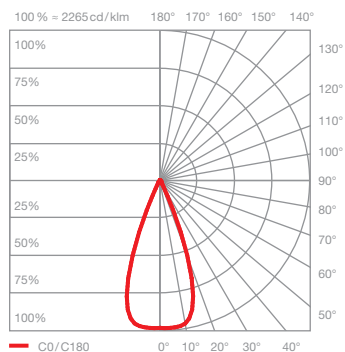

S40 soft

scattered light with soft contour beam angle
(approx. 40°)

inserts: spherical glass
small lens high
fresnel lens

luminous flux: perfect color 18W 870lm

Sito palo VOLT Sito R lighting effects

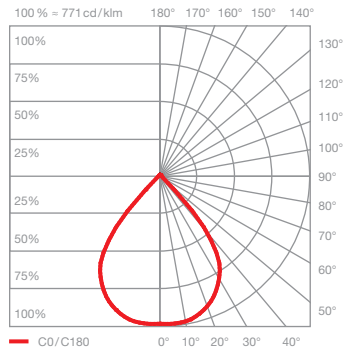

C80 contour

scattered light with contour beam angle
(approx. 80°)

inserts: flat glass
small lens medium

luminous flux: perfect color 18W 1100lm

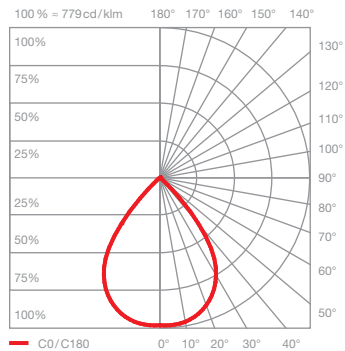

S80 soft

scattered light with soft contour beam angle
(approx. 80°)

inserts: flat glass
small lens medium
soft edge glass

luminous flux: perfect color 18W 980lm

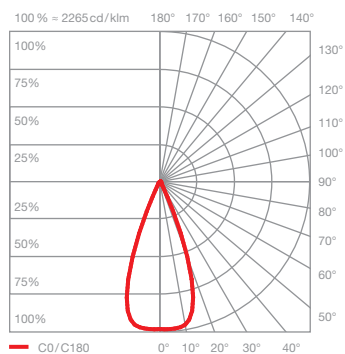

S40 soft

scattered light with soft contour beam angle
(approx. 40°)

inserts: flat glass
small lens high
fresnel lens

luminous flux: perfect color 18W 870lm

Sito palo VOLT mounting accessories

ground anchor
for potting in concrete

width: 95 mm
height: 400 mm
depth: 95 mm

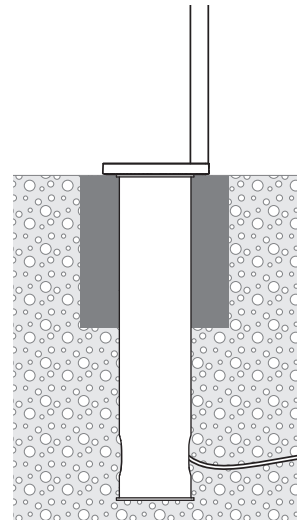
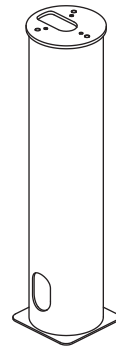

Sito palo VOLT connect several luminaires

through-wired with buried exterior
junction box

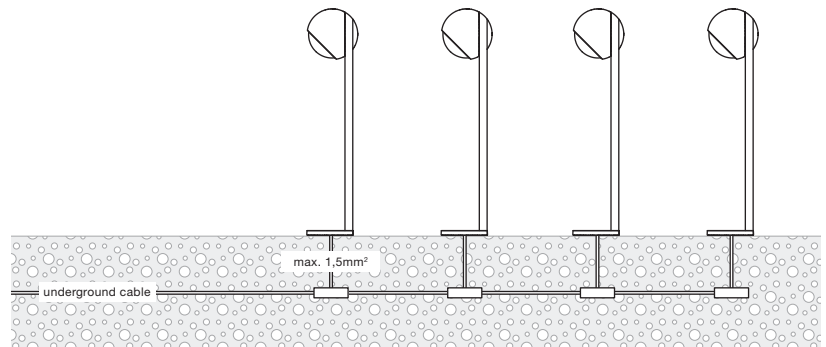

through-wired with plug in terminals

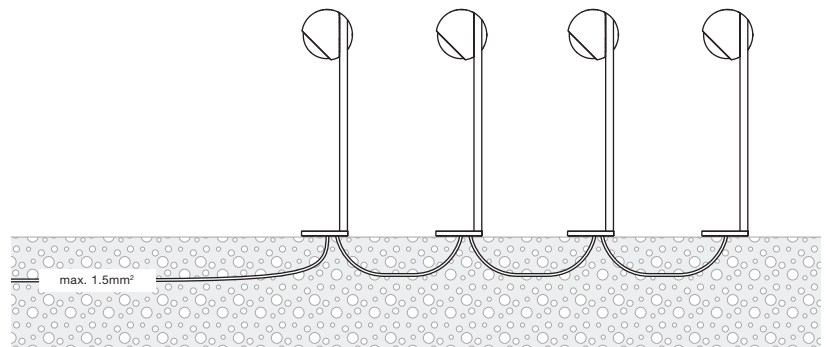

Occhio air module in switch box or
distribution box

max. 4 luminaires

