

Occhio

Mito sospeso var up

Montageanleitung

Mounting instructions

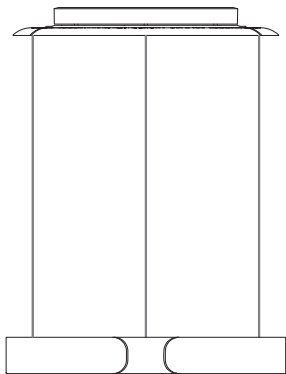

Inhalt / Contents

Sicherheitshinweise	04	Safety precautions	05
Produktbeschreibung	06	Product description	07
Schritt 1		Step 1	
Steuerung	09	Control	09
Mito »air« box (optional)	11	Mito »air« box (optional)	11
Mito set box (standard)	19	Mito set box (standard)	19
Schritt 2		Step 2	
Montage	29	Mounting	29
Einzelleuchten synchronisieren (optional)	43	Synchronization of individual luminaires (optional)	43
Steuerung mit der Occhio air App (optional)	49	Control using the Occhio air app (optional)	49
Steuerung mit dem Occhio air controller (optional)	57	Control using the Occhio air controller (optional)	57
Anhang	61	Appendix	61
Pflegehinweise	62	Care instructions	62
Info & Kontakt	63	Information & contact	63
Technische Daten	64	Technical data	66

Sicherheitshinweise

Lesen Sie die Montage-/Gebrauchsanweisung sorgfältig durch, bevor Sie die Leuchte installieren. Beachten Sie die Sicherheitshinweise in dieser Anleitung genau und bewahren Sie die Anleitung auf.



Dieses Zeichen macht Sie auf eine gefährliche Situation aufmerksam, die eine schwere Verletzung oder den Tod nach sich ziehen kann, wenn sie nicht beachtet wird. Es macht Sie zudem auf mögliche Sachschäden und andere wichtige Informationen in Verbindung mit diesem Produkt aufmerksam.



Die Montage von Elektrokomponenten darf nur von qualifiziertem Fachpersonal durchgeführt werden. Reparaturarbeiten dürfen nur von autorisiertem Fachpersonal oder dem Hersteller durchgeführt werden. Vor allen Arbeiten an der Leuchte (Installation, Reinigung etc.) diese unbedingt vom Stromnetz trennen.



Dieses Zeichen macht Sie auf Situationen aufmerksam, bei denen Sie direkt in das Licht der LED blicken könnten. Dies kann zu Nachbildern und bei längerer Dauer zu Schädigungen der Augen führen.



Sicherheitsabstand zu brennbaren Objekten einhalten: 20 cm!



Dieses Zeichen macht Sie auf heiße Oberflächen aufmerksam, deren Berührung Verbrennungen zur Folge haben können.

Achtung: Die Oberfläche der Leuchte kann nach längerer Betriebsdauer heiß sein! Vor allen Arbeiten an der Leuchte (Montage usw.), Leuchte immer ausschalten und mindestens 30 Minuten abkühlen lassen.

Safety precautions

Read through the mounting/ use instructions carefully before installing the luminaire. Follow the safety precautions in these instructions closely and keep the instructions in a safe place.



This symbol warns you of a dangerous situation which could lead to serious injury or even death if the instructions are not observed. It also draws your attention to possible material damage and provides other important information in connection with this product.



The assembly and installation of electrical components must be carried out only by qualified personnel. Repairs must be carried out only by authorised, qualified personnel or the manufacturer. Before performing any work on the luminaire (installation, cleaning, etc.), it must be disconnected from the mains supply.



This symbol draws your attention to situations in which you could look directly into the light of the LED. This may cause an after-image effect and may result in damage to the eyes if you look at the light directly for prolonged periods.



Maintain the minimum safety distance from flammable materials: 20 cm.



This symbol warns you of hot surfaces, which could cause burns if touched.

Caution: When used for prolonged periods, the surface of the luminaire can become hot. Before performing any work on the luminaire (fitting the luminaire etc.), always switch the luminaire off and let it cool for at least 30 minutes.

Produktbeschreibung

Ringförmige LED Pendelleuchte mit beidseitigem Lichtaustritt und einem Durchmesser von 40 cm oder 60 cm.

Es stehen zwei Lichtwirkungen zur Wahl. table (wide) für die Anwendung über Tischen – breit abstrahlendes Licht nach unten und oben. room (narrow) für frei im Raum hängende Leuchten – gebündeltes Licht nach unten, diffuses Licht nach oben.

Die Pendellänge ist stufenlos einstellbar von 50–200 cm.

Version mit integriertem Vorschaltgerät für Aufputzmontage, Anschluss an 230 V AC Netzspannung. Steuerbar über »touchless control« (am head) und Occhio air, alternativ dimmbar via Phasenabschnittdimmer*.

Die Farbtemperatur ist stufenlos steuerbar via »touchless control« oder Occhio air von 2700–4000 K oder voreinstellbar (2700 / 3000 / 3500 / 4000 K).

* Liste kompatibler Dimmer: www.occhio.de/dim, Phasenabschnittdimmer nicht kombinierbar mit »touchless control« und Occhio air

Product description

Annular LED suspended luminaire with double-sided light emission and a diameter of 40 cm or 60 cm.

There is a choice of two lighting effects. table (wide) for use over tables – wide light beam downwards and upwards. room (narrow) for freely suspended luminaire lighting – concentrated light beam directed downwards, diffused light directed upwards.

The suspension length is continuously adjustable from 50 to 200 cm.

Version with integrated power supply unit for mounting on plaster surfaces; connection to 230 V AC mains voltage. Can be controlled via »touchless control« (on the head) and Occhio air; alternatively, dimmable via a trailing-edge phase cut dimmer*.

The color temperature can be continuously controlled via »touchless control« or Occhio air from 2700 to 4000 K or can be preset (2700/3000/3500/4000 K).

* For a list of compatible dimmers, see www.occhio.de/dim_en, trailing-edge phasecut dimmer can not be combined with »touchless control« and Occhio air

Steuerung

Funktionen / Steuerungsmöglichkeiten der Leuchte einstellen.

Control

Set functions / control options of the luminaire.

Mito »air« box (optional)

Seite / page 11

Mito set box (standard)

Seite / page 19

Mito »air« box
(optional)

Mito »air« box (optional)

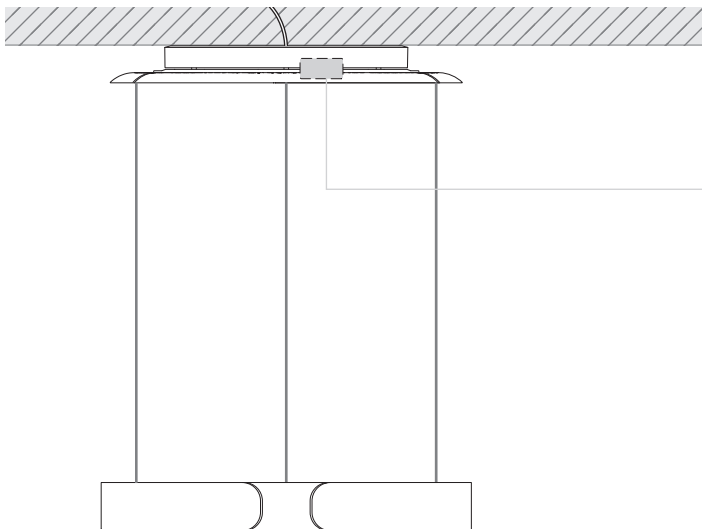



SENSOR = »air« + »touchless control«

Bluetooth- und Gestensteuerung / bluetooth and gesture control
(Seite / page 14)

- schalten / switching
- dimmen / dim
- up / down fading
- color tune

SENSOR OFF = »air«

Bluetoothsteuerung / bluetooth control (Seite / page 16)

- schalten / switching
- dimmen / dim
- up / down fading
- color tune

Nicht kombinierbar mit einem externen Phasenabschrittdimmer.

Can not be combined with an external trailing-edge phasecut dimmer.

» air « + » touchless control «

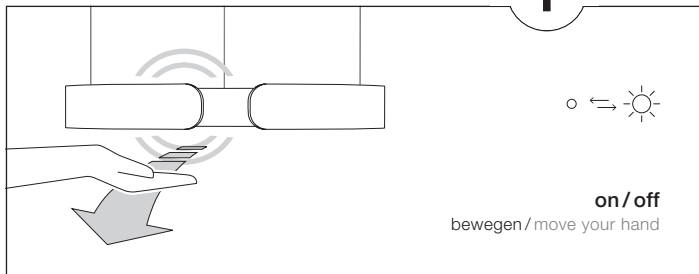
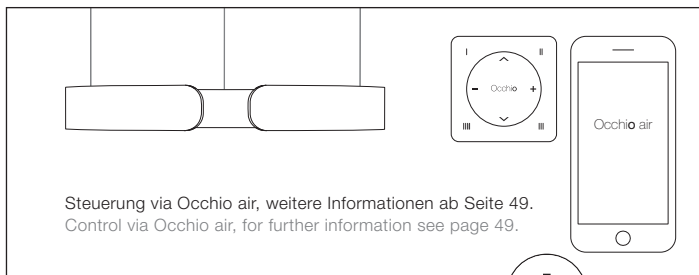
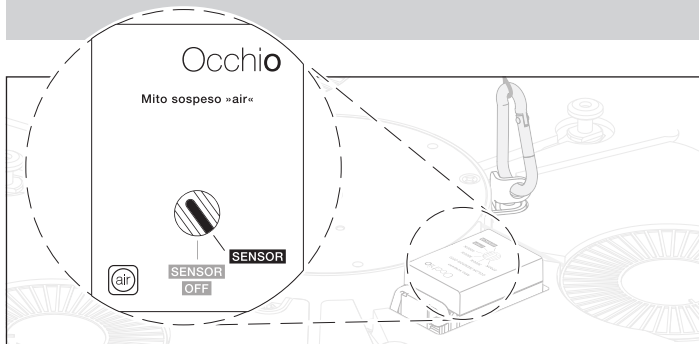

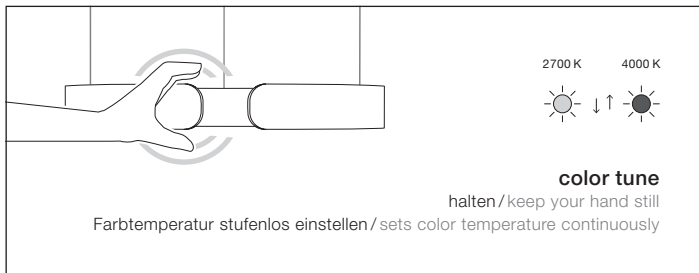
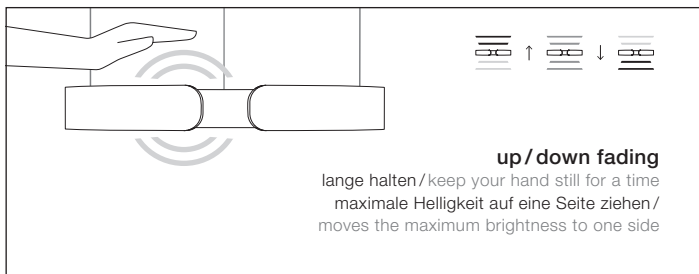
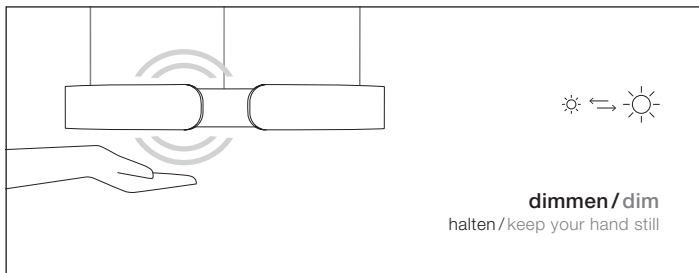

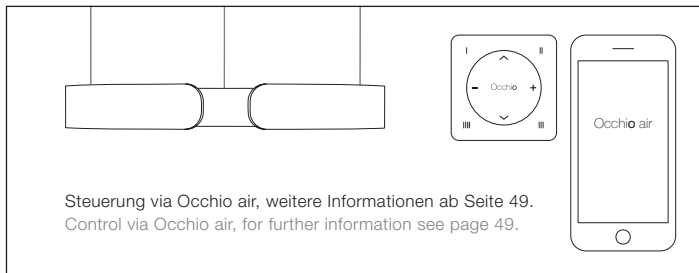
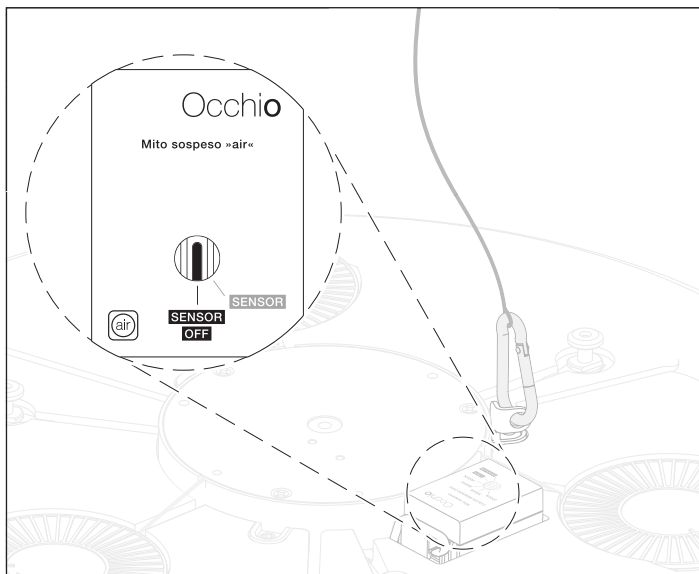



Mito set box
(standard)

Mito set box (standard)

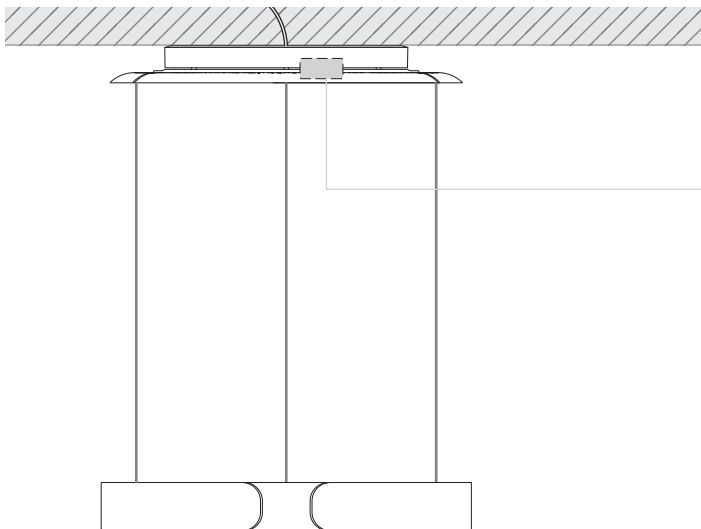

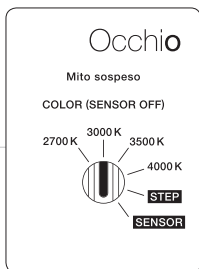

SENSOR = »touchless control«*

Gestensteuerung / gesture control (Seite / page 22)

- schalten / switching
- dimmen / dim
- up / down fading
- color tune

STEP = STEP**

extern schalten und dimmen / switch and dim externally
(Seite / page 24)

- up / down Verhältnis einstellbar (5 Stufen)
up / down reation adjustable (5 stages)
- Farbtemperatur einstellbar (4 Stufen)
color temperature adjustable (4 stages)

COLOR (SENSOR OFF)

2700 K 3000 K 3500 K 4000 K = **color preset****

Farbtemperatur voreinstellbar, extern schalten und dimmen /
color temperature pre-settable switch and dim externally
(Seite / page 26)

- extern schalten und dimmen /
switch and dim externally

* **Nicht kombinierbar** mit einem externen
Phasenabschrittdimmer.

** **Kombinierbar** mit einem externen
Phasenabschrittdimmer.

* **Can not be combined** with an external
trailing-edge phasecut dimmer.

** **Can be combined** with an external
trailing-edge phasecut dimmer.

» touchless control «

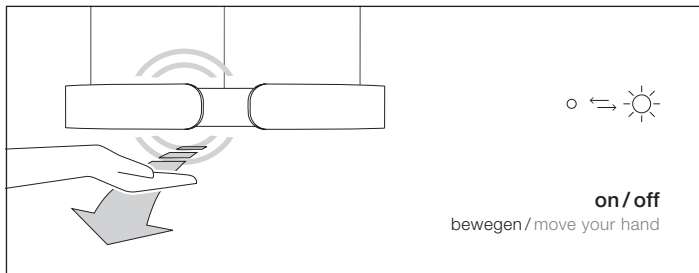
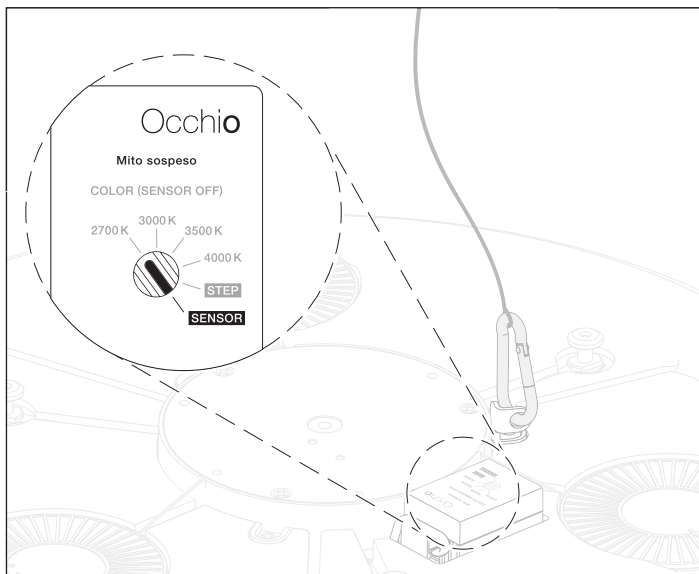

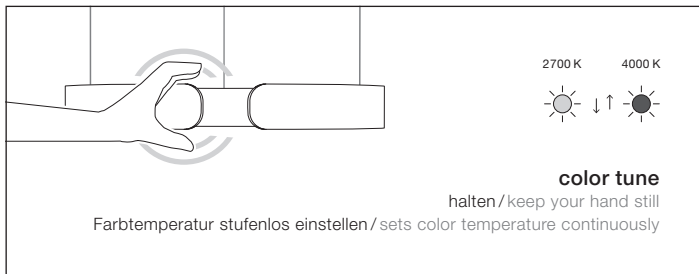
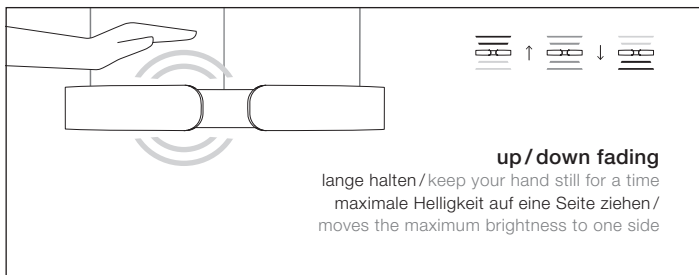
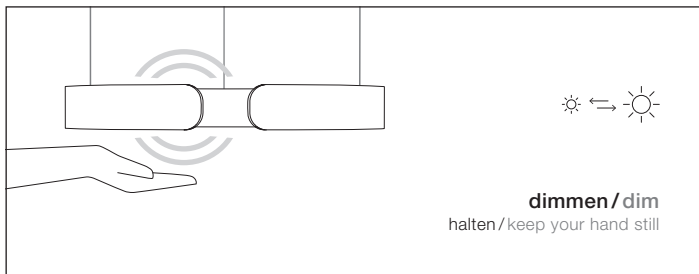

STEP (Sensor aus / sensor off)

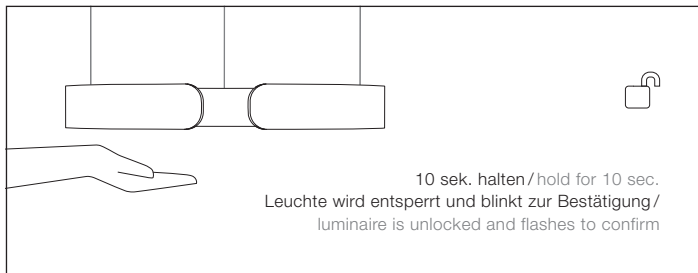
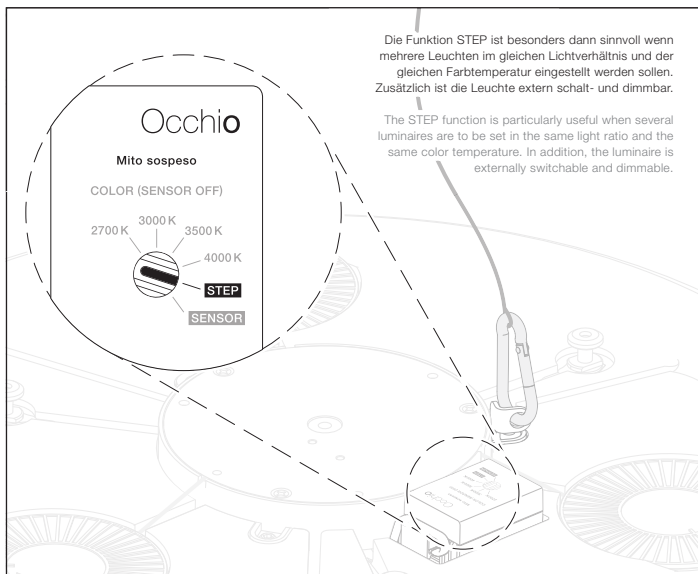

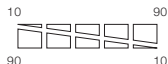

up/down

Verhältnis einstellbar / relation adjustable

lange halten / keep your hand still for a time

Lichtverhältnis in 5 Stufen einstellen / sets the lighting conditions in 5 stages

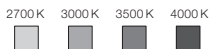

» color tune «

Farbtemperatur einstellbar / color temperature adjustable

lange halten / keep your hand still for a time

Farbtemperatur in 4 Stufen einstellen / sets color temperature in 4 stages



5 Min. warten oder aus- und einschalten / wait for 5 min. or switch off and on

Einstellung ist nun gespeichert / the setting is now saved

phasenabschnitt dimmbar / trailing-edge phase cut dimmable

color preset («touchless control» deaktiviert/
»touchless control« deactivated)

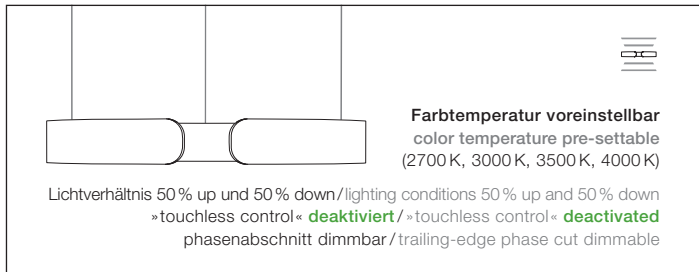
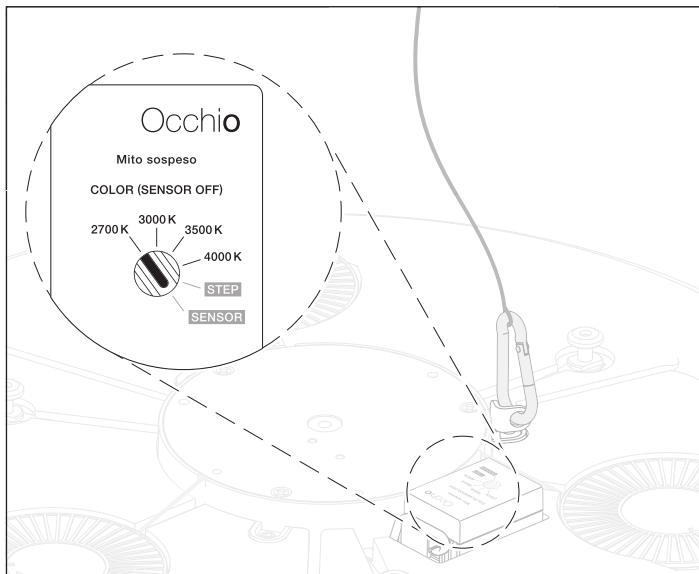



Montage

Mounting

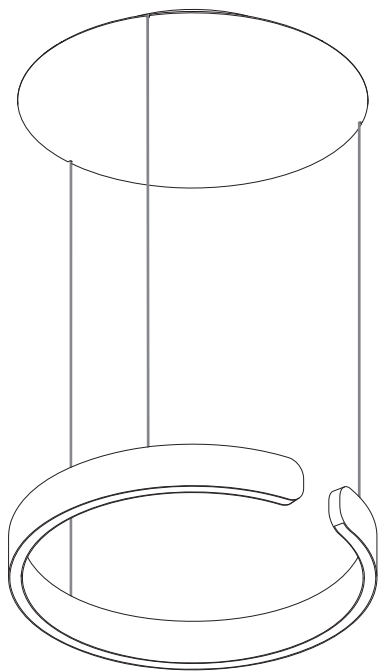

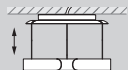

Deckenauslass / ceiling outlet
230V AC

Dübel / screw anchor

Deckenbefestigung inkl. Konverter /
ceiling mount incl. converter

Montageseil / mounting cord

Schrauben / screws

Baldachin mit integrierter
Höhenverstellung / canopy with
integrated height adjustment

Mito sospeso head

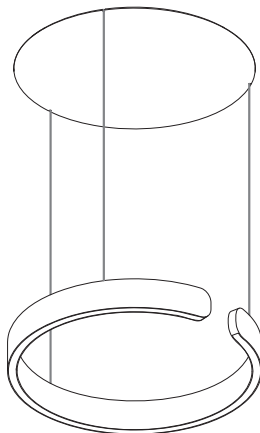
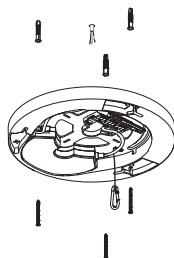

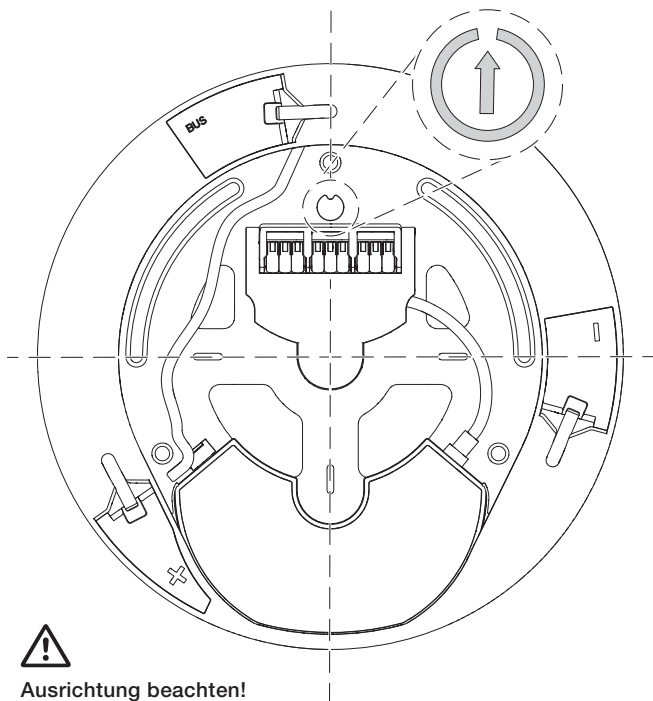

Ausrichtung beachten!
Observe alignment!

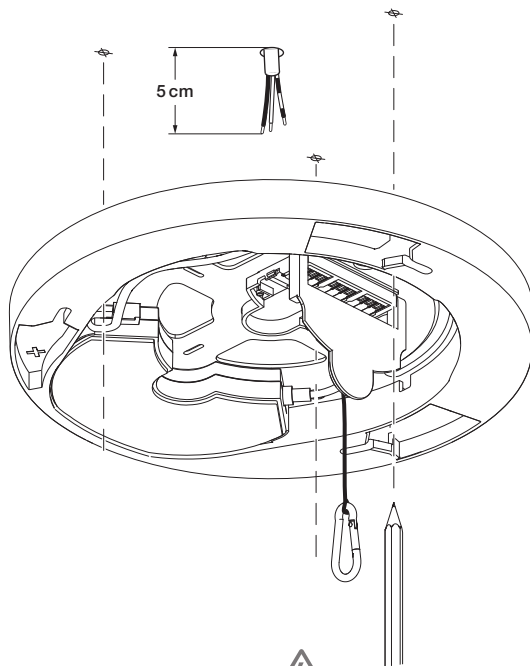
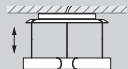

Achtung!
Vor der Montage alle
stromführenden Leitungen
vom Stromnetz trennen!



Caution!
Before mounting, disconnect
all currentcarrying lines
from the mains supply!

Montage / Mounting

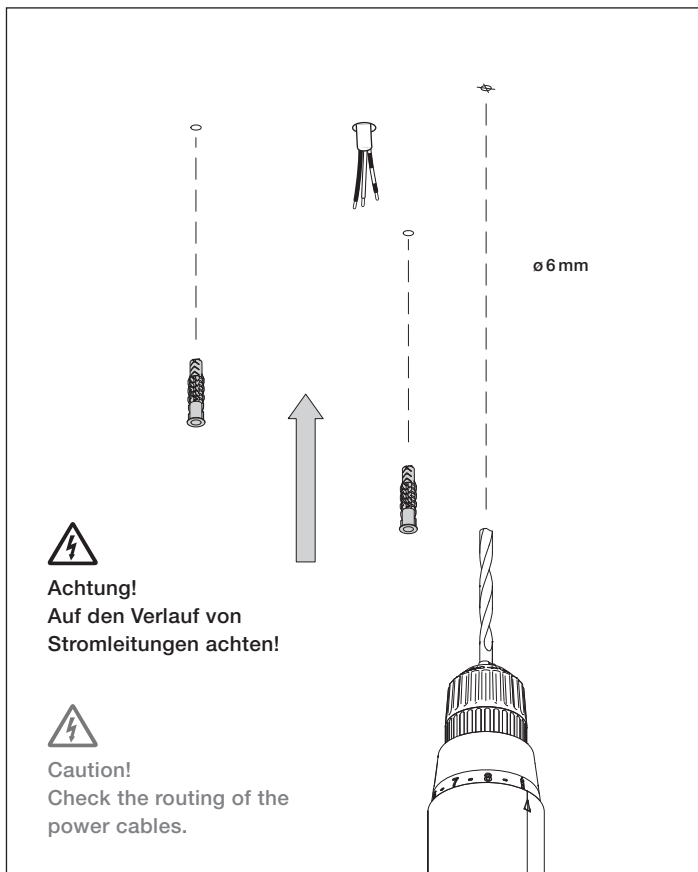

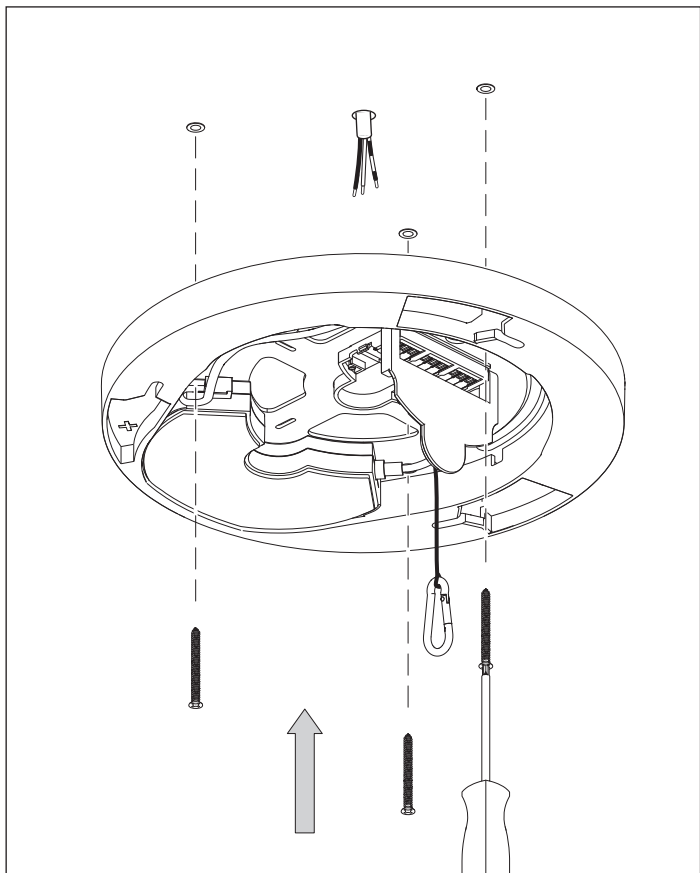
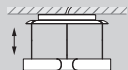

Montage / Mounting

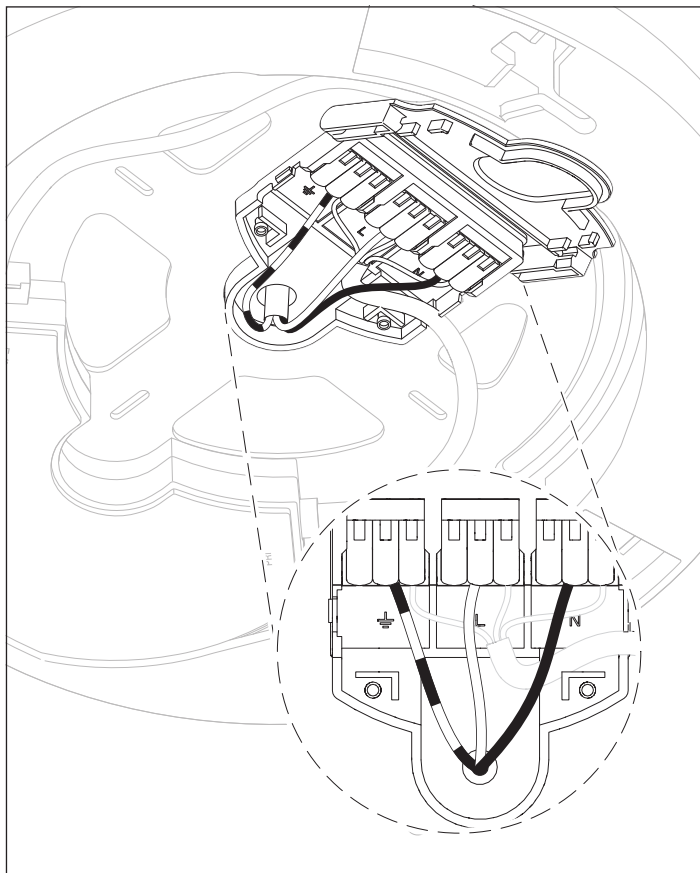

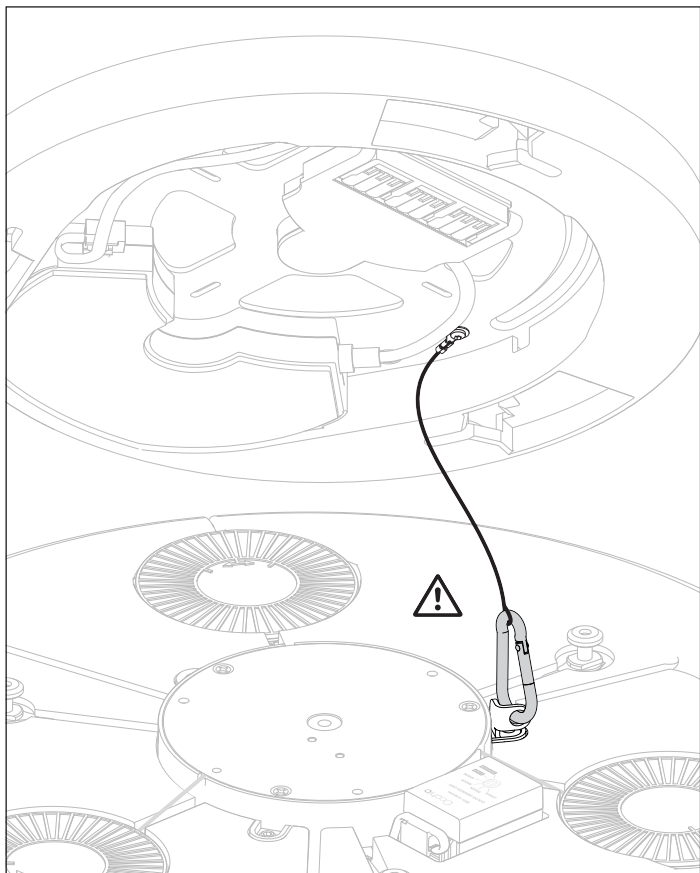
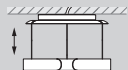

Montage / Mounting

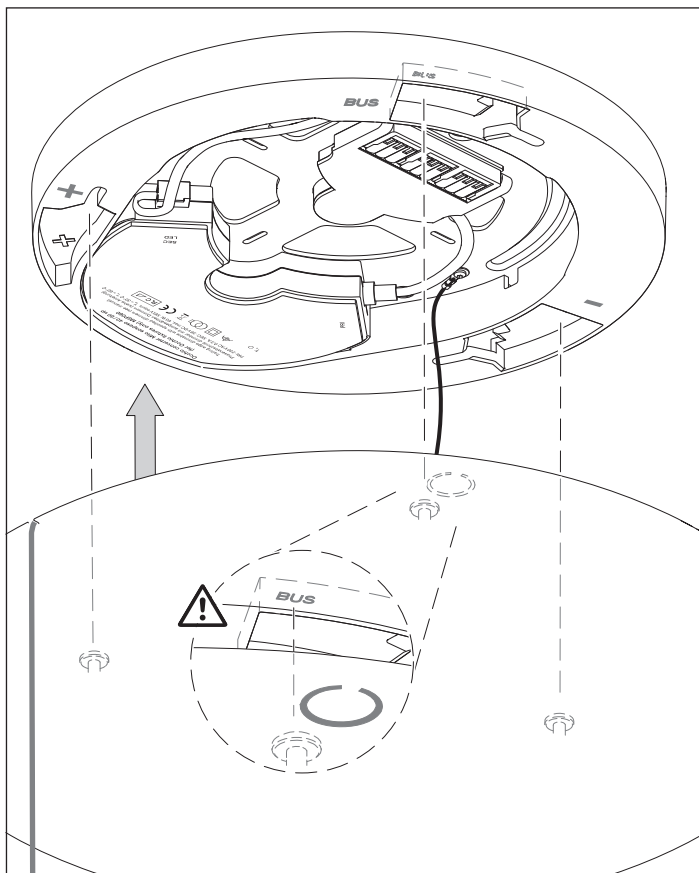

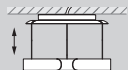

**Baldachin drehen, bis
dieser hörbar einrastet
und Markierung prüfen!**

Turn canopy until you
hear it click into place
and check sign!

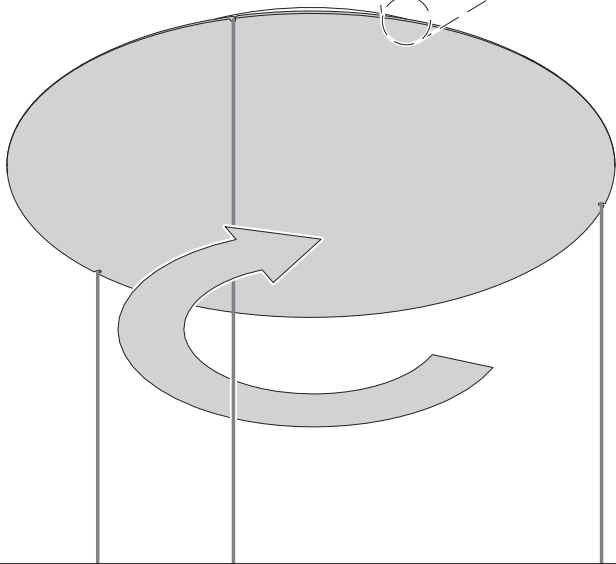
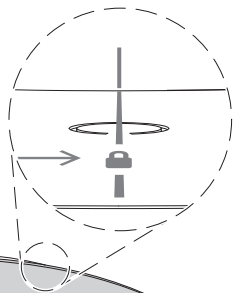

Feinjustierung
fine adjustment

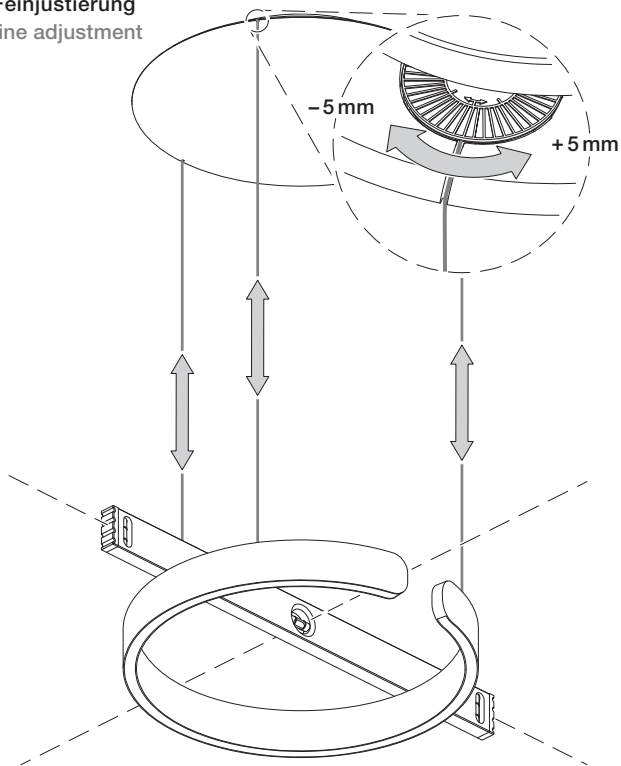

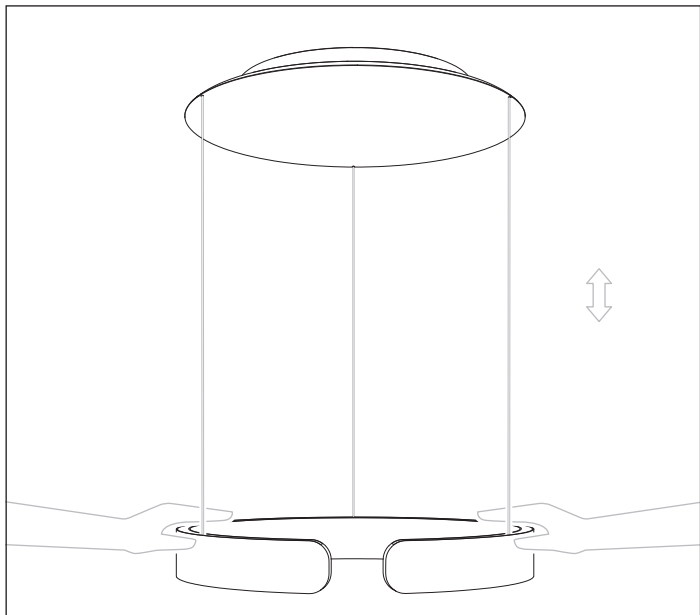
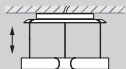

Die Leuchte ist nun fertig montiert.

The luminaire is now completely assembled.

Die Höhe kann nun stufenlos am head eingestellt werden.

The height can now be adjusted steplessly on the head

Einzeleuchten synchronisieren (optional)

Nur bei Montage auf Hohlraumdecken!

Synchronization of individual luminaires (optional)

Only when mounting on hollow ceiling!

Einzelleuchten synchronisieren (optional) Synchronization of individual luminaires (optional)

L ○
N ○
PE ○

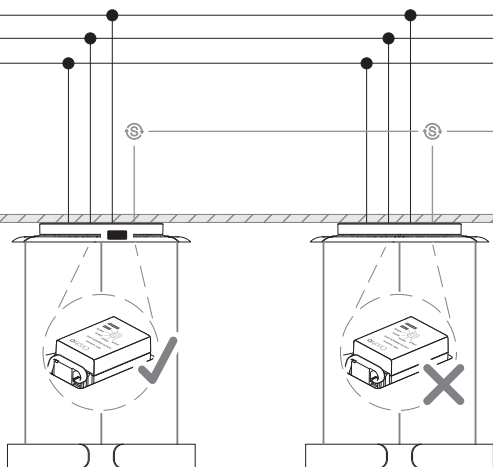

nur 1 × set box
bzw. »air« box

only 1 × set box
or »air« box



**Netzleitung und Sekundär-
leitung getrennt verlegen.**



**Run mains cable and
secondary cable separately.**

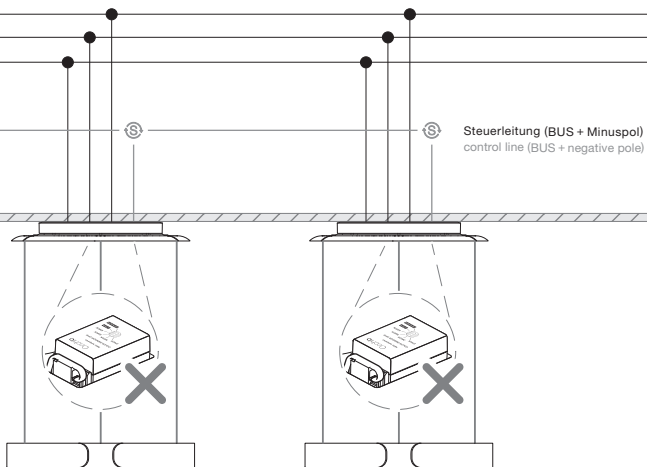
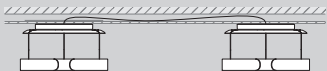

max. 6

max. 6

max. 6

Einzelleuchten synchronisieren (optional) Synchronization of individual luminaires (optional)

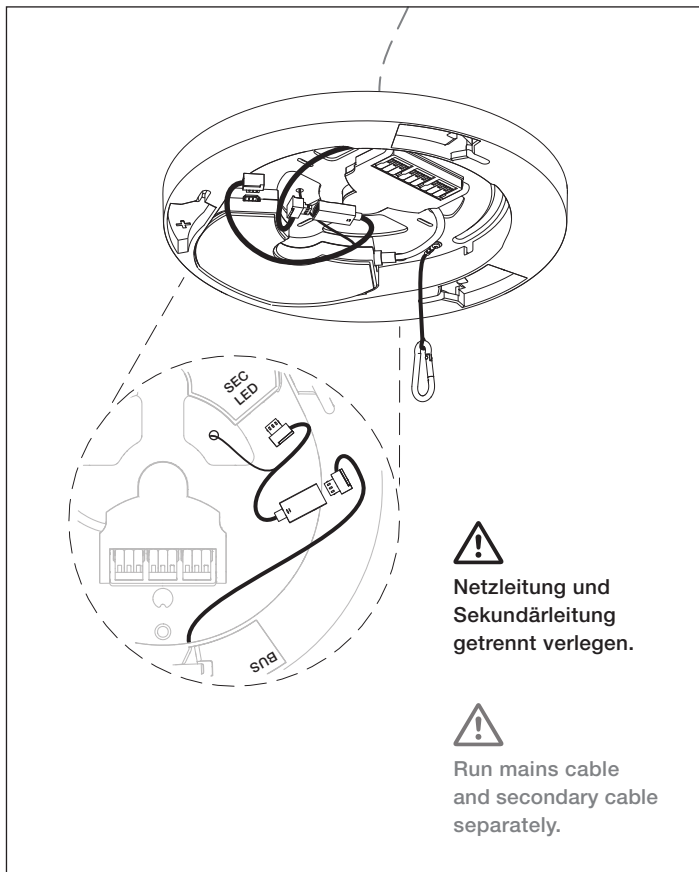

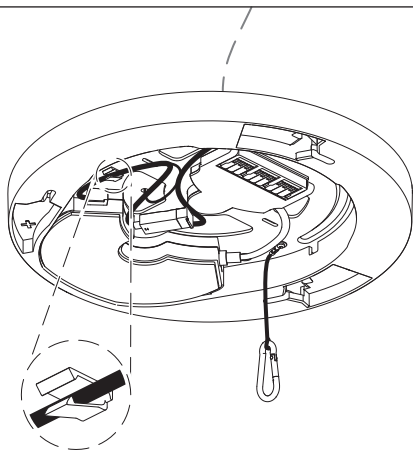
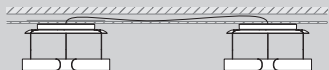

**Kabel mit den
Klemmen sichern,
weiter auf
Seite 37**



**Secure cables with
clamps, continue
on page 37**

Steuerung mit
der Occhio air
App (optional)

Control using
the Occhio air
app (optional)

Steuerung mit der Occhio air App (optional) Control using the Occhio air app (optional)

Quick guide

Die Occhio air Produkte lassen sich mit der Occhio air App einrichten und steuern.

App installieren, App öffnen und angeschlossene Leuchten einrichten.

Occhio air products can be set up and controlled using the Occhio air app.

Install App, open App and set up connected luminaires.



Occhio air tutorials

www.occhio.de/air-tutorials

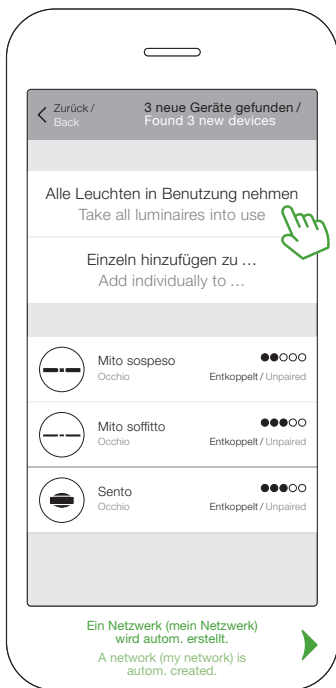

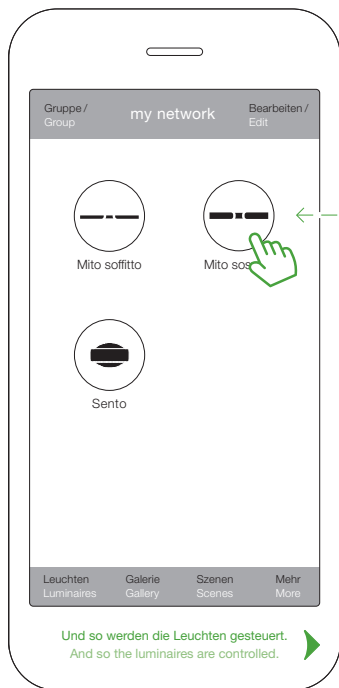

Steuerungsgesten Control gestures

on / off
on / off



antippen
tap

dimmen
dim



wischen
swipe

up / down
faden *



wischen
swipe

color tune **



halten
hold



wischen
swipe

* Mito sospeso / raggio / largo, Sento sospeso,
Sento head (beidseitig / double sided)

** Mito

Steuerung mit der Occhio air App (optional) Control using the Occhio air app (optional)

Nutzung auf mehreren Geräten

Use on several devices

Optional können Sie nun ihr
erstelltes Netzwerk (mein
Netzwerk) mit Anderen teilen.

Optionally, you can now share
your created network (my
network) with others.

1. Netzwerknamen
vergeben

1. Assign name

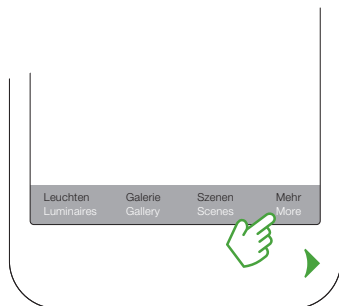

Occhio air tutorials

www.occhio.de/air-tutorials

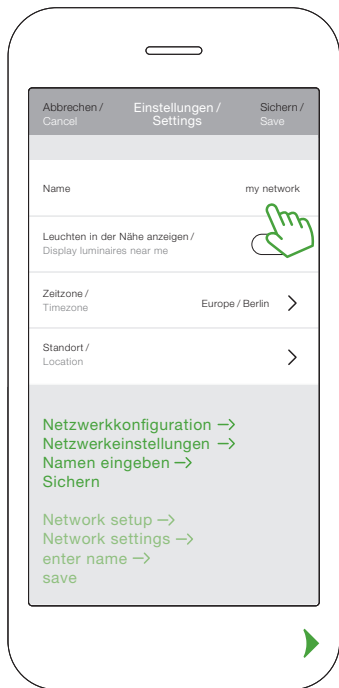

Steuerung mit der Occhio air App (optional) Control using the Occhio air app (optional)

Netzwerk freigeben
und schützen

Share and protect the
network

Occhio air tutorials

www.occhio.de/air-tutorials

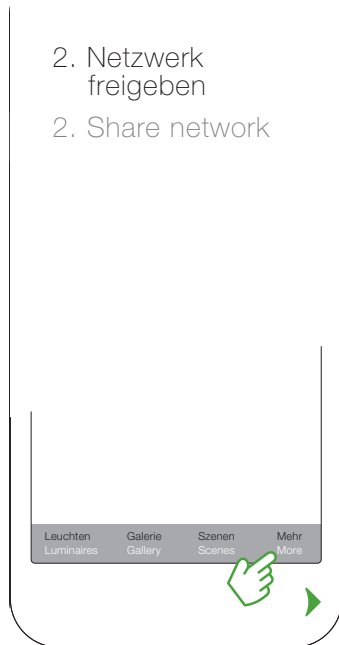

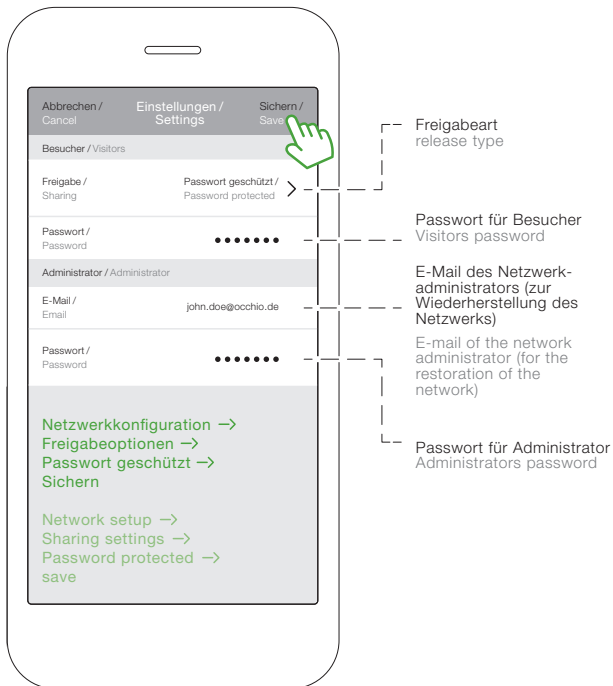

Steuerung mit
dem Occhio air
controller
(optional)

Control using
the Occhio air
controller
(optional)

Steuerung mit dem Occhio air controller (optional) Control using the Occhio air controller (optional)

Occhio air controller

Intuitiv bedienbare Fernbedienung mit vier programmierbaren Tasten (Einrichtung via Occhio air App). Unabhängig von der App können einzelne Leuchten, Gruppen und Szenen gesteuert werden. Optional mit Wandhalterung erhältlich.

Maximaler Bedienkomfort und umfassende Steuerung via Bluetooth 4.0 (Bluetooth Low Energy). Schalten, dimmen, faden, color tune von einzelnen Leuchten, Gruppen und Szenen.

Occhio air controller

Intuitive remote control with four programmable buttons (setup via Occhio air app). Individual luminaires, groups and scenes can be controlled regardless of the app. Available with optional wall mount.

Maximum ease of use and total control via Bluetooth 4.0 (Bluetooth low energy). Switching, dimming, fading, color tune of individual luminaires, groups and scenes.



Zum Einrichten des Occhio air controllers wird die Occhio air App benötigt. Eine Video-Kurzanleitung kann unter: www.occhio.de/air-tutorials aufgerufen werden.

To set up the Occhio air controller, the Occhio air app is required. A video quick start guide can be called up at www.occhio.de/air-tutorials.

schalten/switch



⏏ - ☰ einzelne Leuchten, Gruppen, oder Szenen schalten

⏏ - ☰ switch individual luminaires, groups or scenes

dimmen/dim



⊕ - ☰ einzelne Leuchten, Gruppen, oder Szenen dimmen

⊕ - ☰ dims individual luminaires, groups or scenes

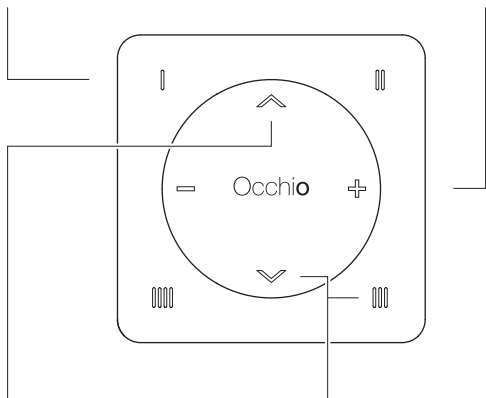

faden*



⤴ ⤵ einzelne Leuchten, Gruppen oder Szenen faden (up/down Verhältnis ändern)

⤴ ⤵ fades individual luminaires, groups or scenes (change up/down relation)

color tune**

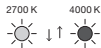

⏏ - ☰ and ⤴ ⤵ Farbtemperatur einzelner Leuchten, Gruppen oder Szenen einstellen

⏏ - ☰ and ⤴ ⤵ adjust color temperature of individual luminaires, groups or scenes

* Mito sospeso, Sento sospeso, Sento head (beidseitig/double sided) ** Mito

Anhang

Appendix

Pflegehinweise

Care instructions

Leuchte nur in abgekühltem Zustand reinigen! Zur Reinigung der Leuchte ein trockenes Mikrofasertuch verwenden. Detaillierte Pflegehinweise sind unter www.occhio.de/de/company/faq zu finden.

Always allow the luminaire to cool down before cleaning! To clean the luminaire, use a dry microfibre cloth. Detailed care instructions are available at www.occhio.de/en/company/faq.

Info & Kontakt

Information & contact





Weitere Fragen beantwortet gerne
Ihr Occhio Fachhändler

Your Occhio specialist retailer will
gladly answer any other questions

www.occhio.de
info@occhio.de

Technische Daten

Technische Daten Leuchte

Artikelbezeichnung	Mito sospeso 40 var up, Mito sospeso 60 var up
Abmessungen	Mito sospeso 40 up: head ø 400, H 52 mm, Baldachin ø 380 mm, H 39,5 mm Mito sospeso 60 up: head ø 600, H 52 mm, Baldachin ø 576 mm, H 39,5 mm
Höhenverstellung	Mito sospeso var up: 500–2000 mm (variabel)
Schutzklasse	2
Anschluss	230 V AC
Dimmung	via »touchless control« und Occhio air (optional) oder via Phasenabschnittdimmer (Liste kompatibler Dimmer: www.occhio.de/dim , Phasenabschnitt- dimmer nicht kombinierbar mit »touchless control« und Occhio air)
Material	Aluminium, Stahl, lackiert, eloxiert oder PVD-beschichtet, Kunststoff, optischer Silikon
LED-Leistung	Mito sospeso 40 up: 40 W Mito sospeso 60 up: 60 W
Zulässige Betriebsbedingung	max. 30°C nur im Innenbereich betreiben
Prüfzeichen	IP 20 CE    

Technische Daten Leuchtmittel





Leuchtmittel	Occhio »color tune« LED
Ausführung	LED-board
Lebensdauer	> 50.000 Std.
Energieeffizienzklasse – EEK	A+

Entsorgung

Bei örtlicher Entsorgungsstelle entsorgen. Mito sospeso var up ist recyclebar; RoHS-konform. **Nicht in den Hausmüll geben!**

Technical data

Technical data luminaire

Product designation	Mito sospeso 40 var up, Mito sospeso 60 var up
Dimensions	Mito sospeso 40 up: head ø 400, H 52 mm, canopy ø 380 mm, H 39,5 mm Mito sospeso 60 up: head ø 600, H 52 mm, canopy ø 576 mm, H 39,5 mm
Height adjustment	Mito sospeso var up: 500 – 2000 mm (variable)
Safety class	2
Connection	230 V AC
Dimming	via »touchless control« and Occhio air (optional) or via trailing-edge phasecut dimmer (For a list of compatible dimmers, see www.occhio.de/dim_en , trailing-edge phasecut dimmer can not be combined with »touchless control« and Occhio air)
Material	Aluminium, painted, anodised or PVD-coated steel, plastic, optical silicone
LED power	Mito sospeso 40 up: 40 W Mito sospeso 60 up: 60 W
Permitted operating conditions	max. 30°C for indoor use only
Test symbols	IP 20 CE     

Technical data light source

Light source	Occhio »color tune« LED
Version	LED-board
Lifetime	> 50.000 h
Energy efficiency class – EEC	A+

Disposal

Dispose of at a local disposal site. Mito sospeso var up is recyclable and RoHS compliant. **Do not dispose of with the household waste!**

Occhio

Occhio GmbH
Wiener Platz 7
81667 München
Fon +49-89-44 77 86 30
Fax +49-89-44 77 86 39
info@occhio.de
www.occhio.de



010405944596685910