

Occhio

Mito sospeso var up

Montageanleitung

Mounting instructions

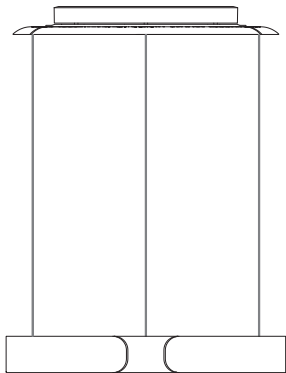

Inhalt / Contents

Sicherheitshinweise	04	Safety precautions	05
Produktbeschreibung	06	Product description	07
Mito sospeso Steuerung	09	Mito sospeso control	09
Montage Mito sospeso var up	21	Mounting Mito sospeso var up	21
Steuerung mit der »air« App (optional)	35	Control with the »air« app (optional)	35
Steuerung mit dem »air« controller (optional)	39	Control with the »air« controller (optional)	39
Anhang	43	Appendix	43
Pflegehinweise	44	Care instructions	44
Info & Kontakt	45	Information & contact	45
Technische Daten	46	Technical data	48

Sicherheitshinweise

Lesen Sie die Montage-/Gebrauchsanweisung sorgfältig durch, bevor Sie die Leuchte installieren. Beachten Sie die Sicherheitshinweise in dieser Anleitung genau und bewahren Sie die Anleitung auf.



Dieses Zeichen macht Sie auf eine gefährliche Situation aufmerksam, die eine schwere Verletzung oder den Tod nach sich ziehen kann, wenn sie nicht beachtet wird. Es macht Sie zudem auf mögliche Sachschäden und andere wichtige Informationen in Verbindung mit diesem Produkt aufmerksam.



Die Montage von Elektrokomponenten darf nur von qualifiziertem Fachpersonal durchgeführt werden. Reparaturarbeiten dürfen nur von autorisiertem Fachpersonal oder dem Hersteller durchgeführt werden. Vor allen Arbeiten an der Leuchte (Installation, Reinigung etc.) diese unbedingt vom Stromnetz trennen.



Dieses Zeichen macht Sie auf Situationen aufmerksam, bei denen Sie direkt in das Licht der LED blicken könnten. Dies kann zu Nachbildern und bei längerer Dauer zu Schädigungen der Augen führen.



Sicherheitsabstand zu brennbaren Objekten einhalten: 20 cm!



Dieses Zeichen macht Sie auf heiße Oberflächen aufmerksam, deren Berührung Verbrennungen zur Folge haben können.

Achtung: Die Oberfläche der Leuchte kann nach längerer Betriebsdauer heiß sein! Vor allen Arbeiten an der Leuchte (Montage usw.), Leuchte immer ausschalten und mindestens 30 Minuten abkühlen lassen.

Safety precautions

Read through the mounting/ use instructions carefully before installing the luminaire. Follow the safety precautions in these instructions closely and keep the instructions in a safe place.



This symbol warns you of a dangerous situation which could lead to serious injury or even death if the instructions are not observed. It also draws your attention to possible material damage and provides other important information in connection with this product.



The assembly and installation of electrical components must be carried out only by qualified personnel. Repairs must be carried out only by authorised, qualified personnel or the manufacturer. Before performing any work on the luminaire (installation, cleaning, etc.), it must be disconnected from the mains supply.



This symbol draws your attention to situations in which you could look directly into the light of the LED. This may cause an after-image effect and may result in damage to the eyes if you look at the light directly for prolonged periods.



Maintain the minimum safety distance from flammable materials: 20 cm.



This symbol warns you of hot surfaces, which could cause burns if touched.

Caution: When used for prolonged periods, the surface of the luminaire can become hot. Before performing any work on the luminaire (fitting the luminaire etc.), always switch the luminaire off and let it cool for at least 30 minutes.

Produktbeschreibung

Ringförmige LED Pendelleuchte mit beidseitigem Lichtaustritt und einem Durchmesser von 40 cm oder 60 cm.

Es stehen zwei Lichtwirkungen zur Wahl. table (wide) für die Anwendung über Tischen – breit abstrahlendes Licht nach unten und oben. room (narrow) für frei im Raum hängende Leuchten – gebündeltes Licht nach unten, diffuses Licht nach oben.

Die Pendellänge ist stufenlos einstellbar von 50–200 cm.

Version mit integriertem Vorschaltgerät für Aufputzmontage, Anschluss an 230V AC Netzspannung. Steuerbar über »touchless control« (am head) und Occhio air, alternativ dimmbar via Phasenabschnittdimmer*.

Die Farbtemperatur ist stufenlos steuerbar via »touchless control« oder Occhio air von 2700–4000 K oder voreinstellbar (2700 / 3000 / 3500 / 4000 K).

* Liste kompatibler Dimmer: www.occhio.de/dim, Phasenabschnittdimmer und Occhio air nicht kombinierbar

Product description

Annular LED suspended luminaire with double-sided light emission and a diameter of 40 cm or 60 cm.

There is a choice of two lighting effects. table (wide) for use over tables – wide light beam downwards and upwards. room (narrow) for freely suspended luminaire lighting – concentrated light beam directed downwards, diffused light directed upwards.

The suspension length is continuously adjustable from 50 to 200 cm.

Version with integrated power supply unit for mounting on plaster surfaces; connection to 230 V AC mains voltage. Can be controlled via »touchless control« (on the head) and Occhio air; alternatively, dimmable via a trailing-edge phase cut dimmer*.

The color temperature can be continuously controlled via »touchless control« or Occhio air from 2700 to 4000 K or can be preset (2700/3000/3500/4000 K).

* For a list of compatible dimmers, see www.occhio.de/dim_en, trailing-edge phasecut dimmer and Occhio air not combinable

Mito sospeso
Steuerung

Mito sospeso
control

Funktionsübersicht

Functional overview

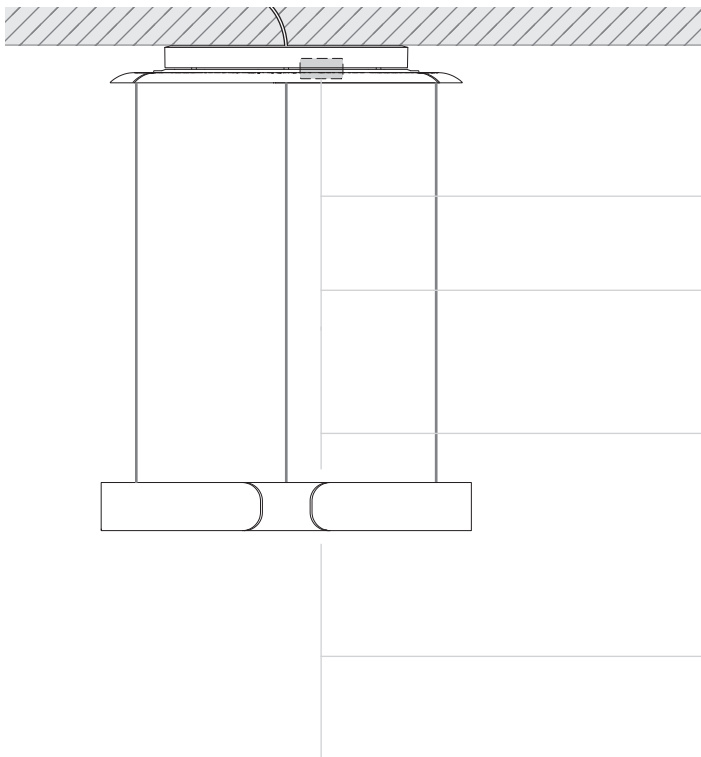



»**touchless control**« (Gestensteuerung/gesture control)

schalten / switch
dimmen / dim
up / down fading
color tune

color preset (extern schalten und dimmen/switch and dim externally)

Farbtemperatur voreinstellbar
color temperature pre-settable



STEP (extern schalten und dimmen/switch and dim externally)

up / down Verhältnis einstellbar (5 Stufen)
up / down reation adjustable (5 stages)
Farbtemperatur einstellbar (4 Stufen)
color temperature adjustable (4 stages)

»**air**« + »**touchless control**« *

(Bluetooth- und Gestensteuerung/bluetooth and gesture control)
Steuerung via »touchless control« oder Occhio air
Control via »touchless control« or Occhio air

»**air**« * (Bluetoothsteuerung/bluetooth control)

Steuerung via Occhio air
Control via Occhio air



* Funktion optional / function optional (Mito sospeso -air- box)

» touchless control «

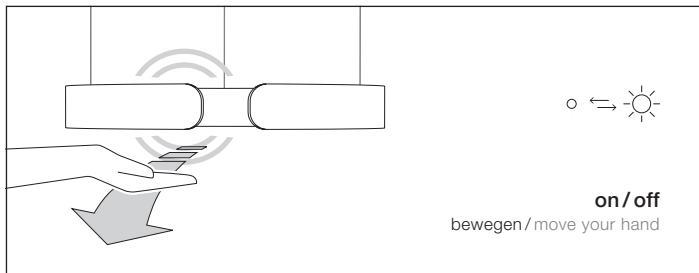
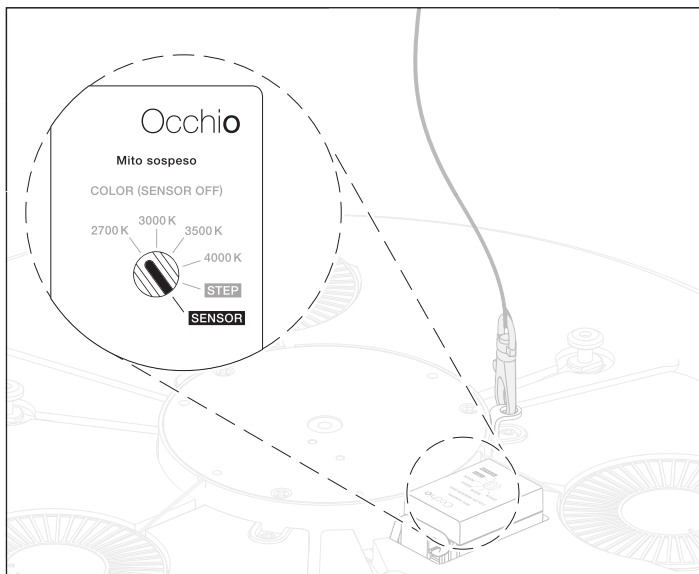

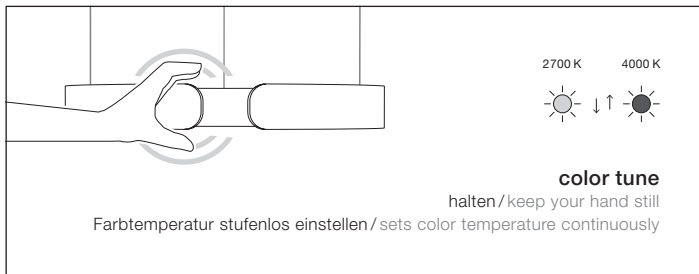
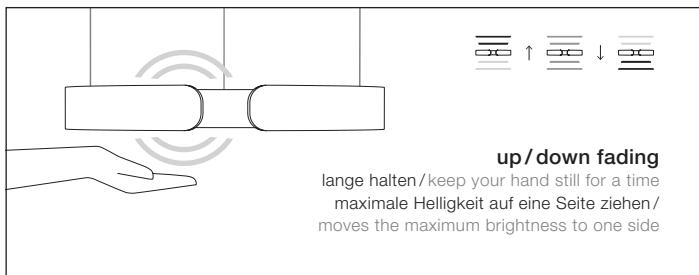
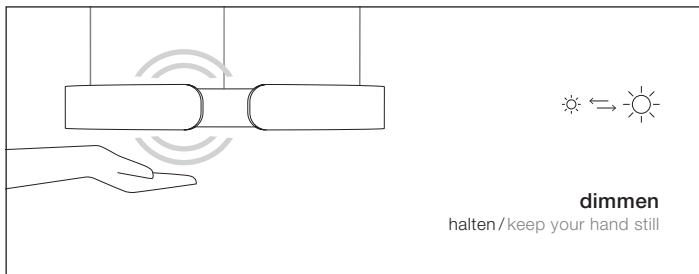

color preset

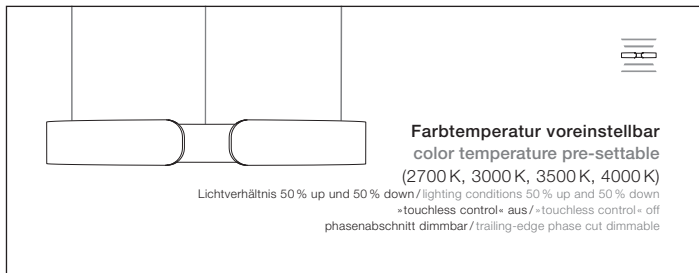
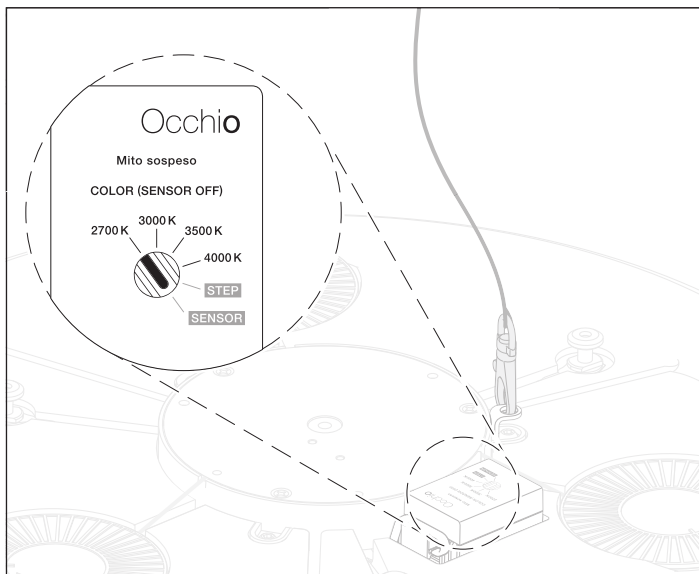



STEP

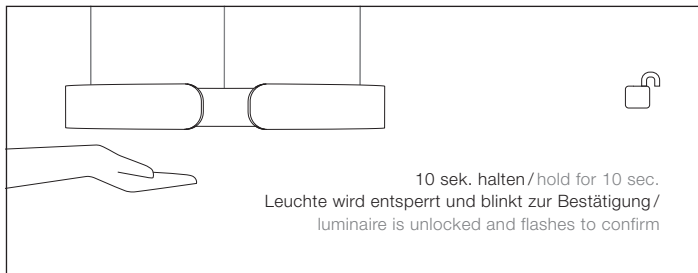
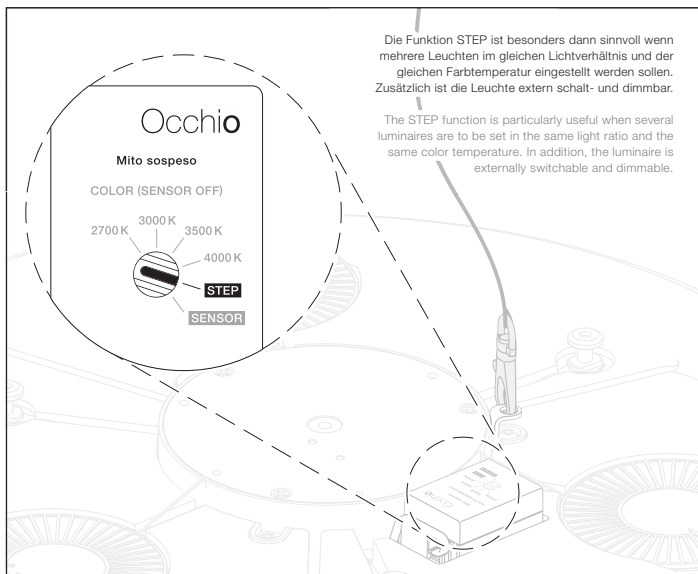



up/down

Verhältnis einstellbar / relation adjustable

lange halten / keep your hand still for a time

Lichtverhältnis in 5 Stufen einstellen / sets the lighting conditions in 5 stages



» color tune «

Farbtemperatur einstellbar / color temperature adjustable

lange halten / keep your hand still for a time

Farbtemperatur in 4 Stufen einstellen / sets color temperature in 4 stages



5 min. warten / wait for 5 min.

Einstellung ist nun gespeichert / the setting is now saved
phasenabschnitt dimmbar / trailing-edge phase cut dimmable

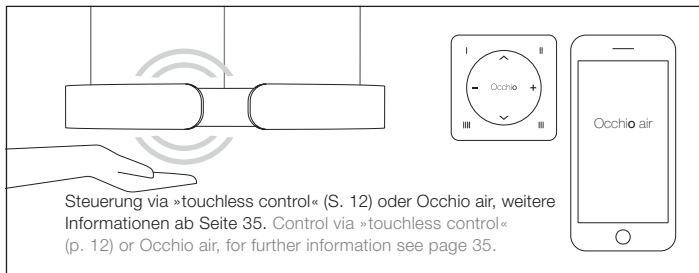

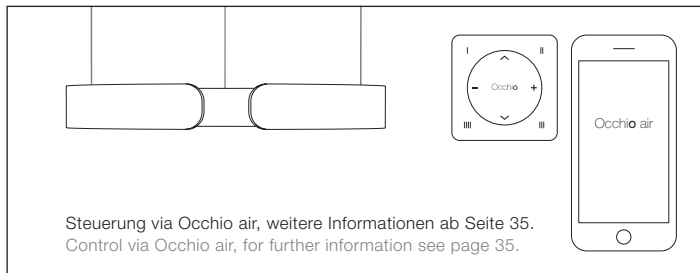
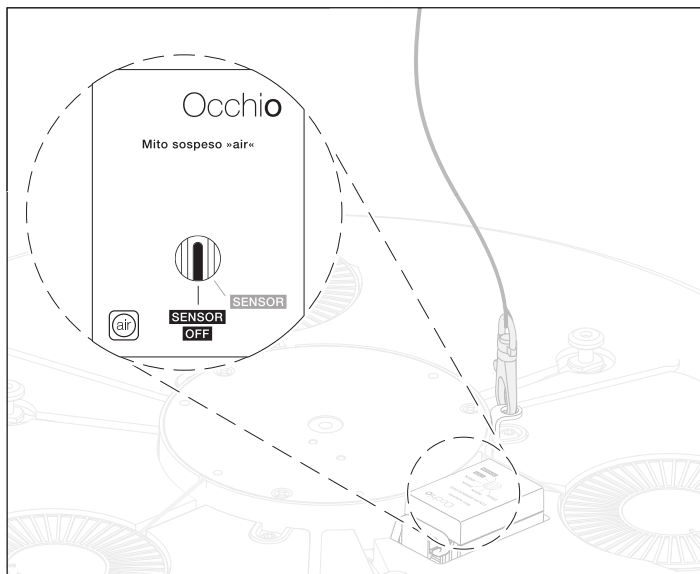

Montage
Mito sospeso
var up

Mounting
Mito sospeso
var up

Montage Mito sospeso var up
Mounting Mito sospeso var up

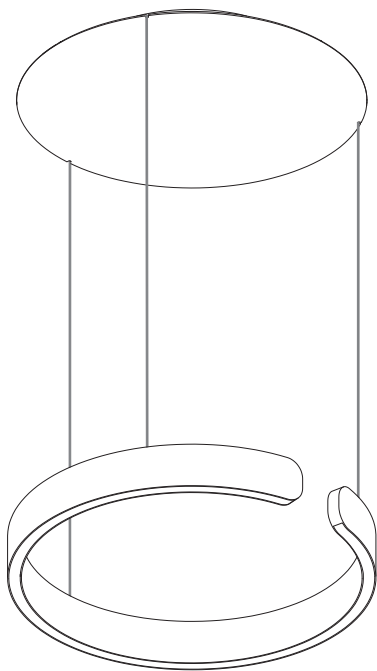

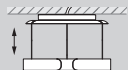

Deckenauslass / ceiling outlet
230V AC

Dübel / screw anchor

Deckenbefestigung inkl. Konverter /
ceiling mount incl. converter

Fallschutz / fall protection

Schrauben / screws

Baldachin mit integrierter
Höhenverstellung / canopy with
integrated height adjustment

Mito sospeso head

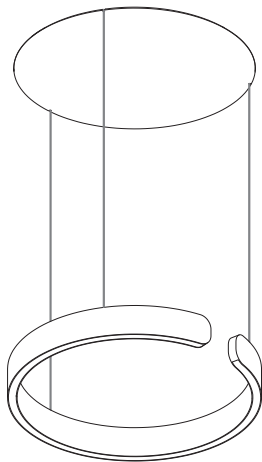
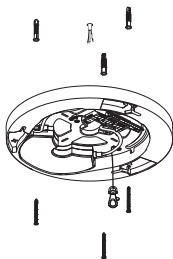

Montage Mito sospeso var up

Mounting Mito sospeso var up

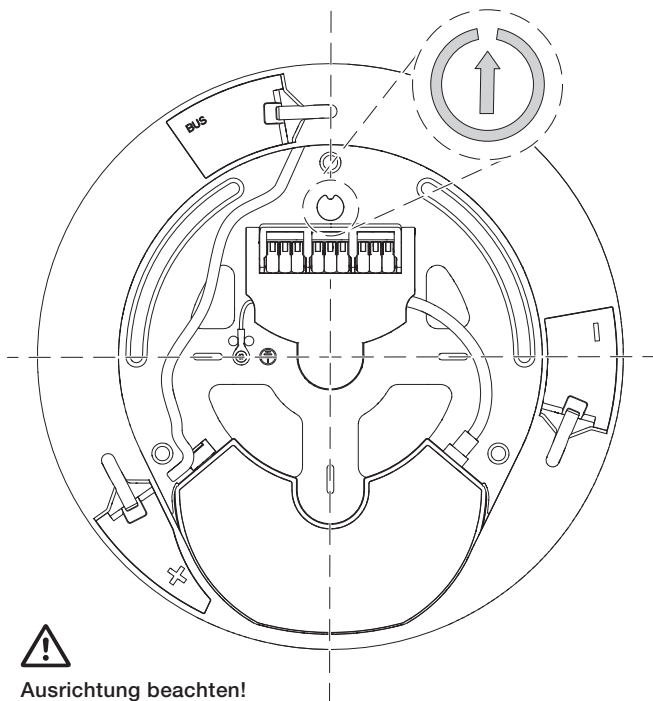

Ausrichtung beachten!
Observe alignment!

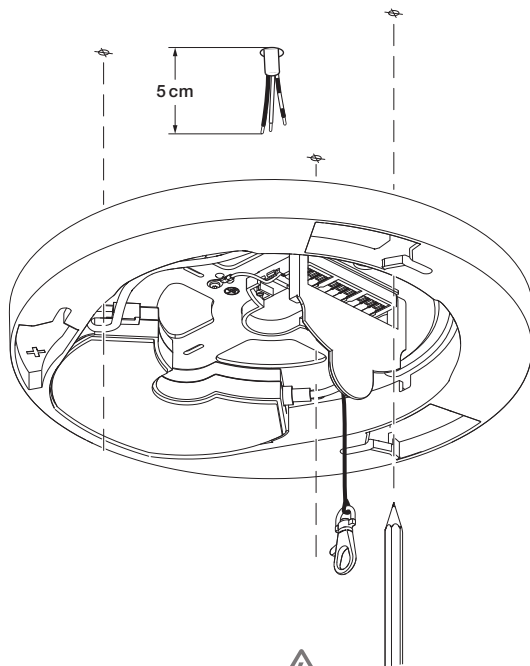
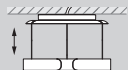

Achtung!
Vor der Montage alle
stromführenden Leitungen
vom Stromnetz trennen!



Caution!
Before mounting, disconnect
all currentcarrying lines
from the mains supply!

Montage Mito sospeso var up Mounting Mito sospeso var up

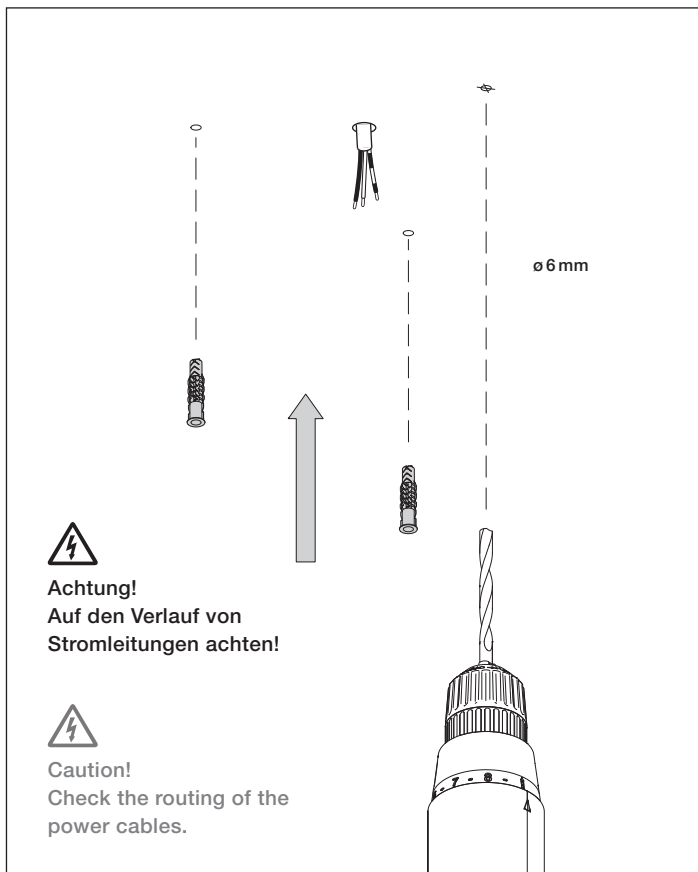

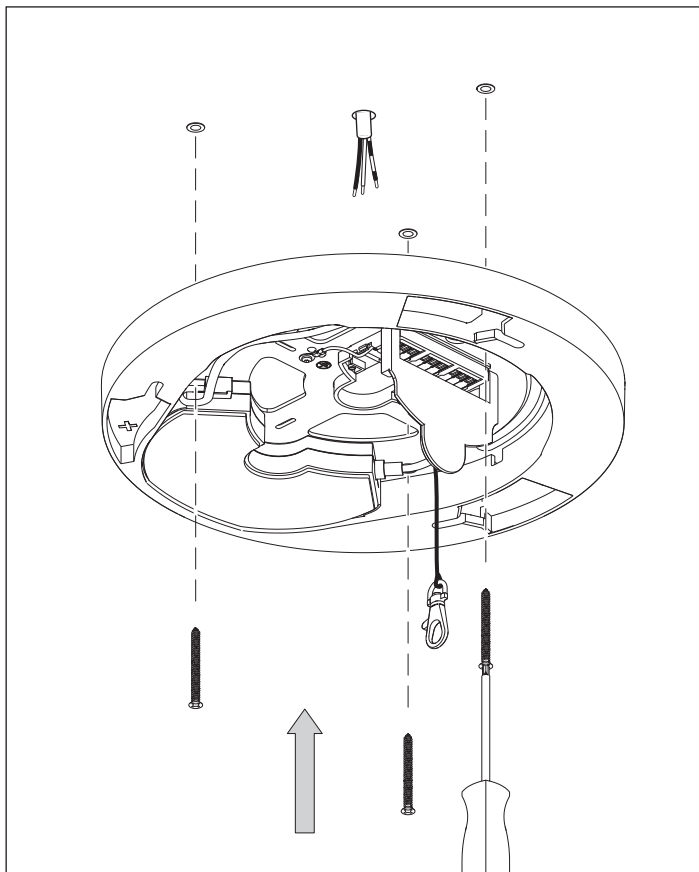
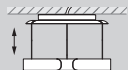

Montage Mito sospeso var up

Mounting Mito sospeso var up

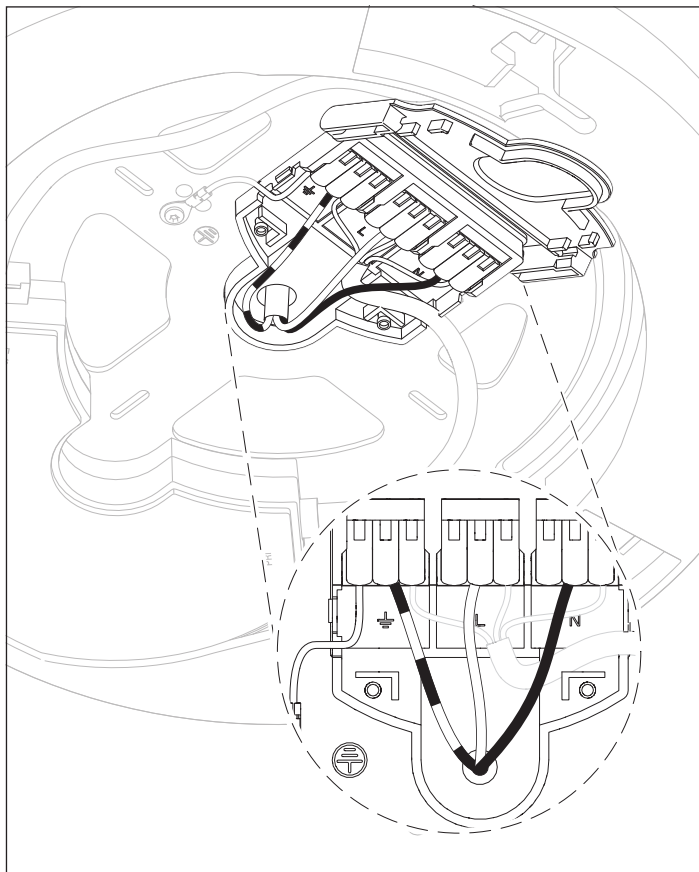

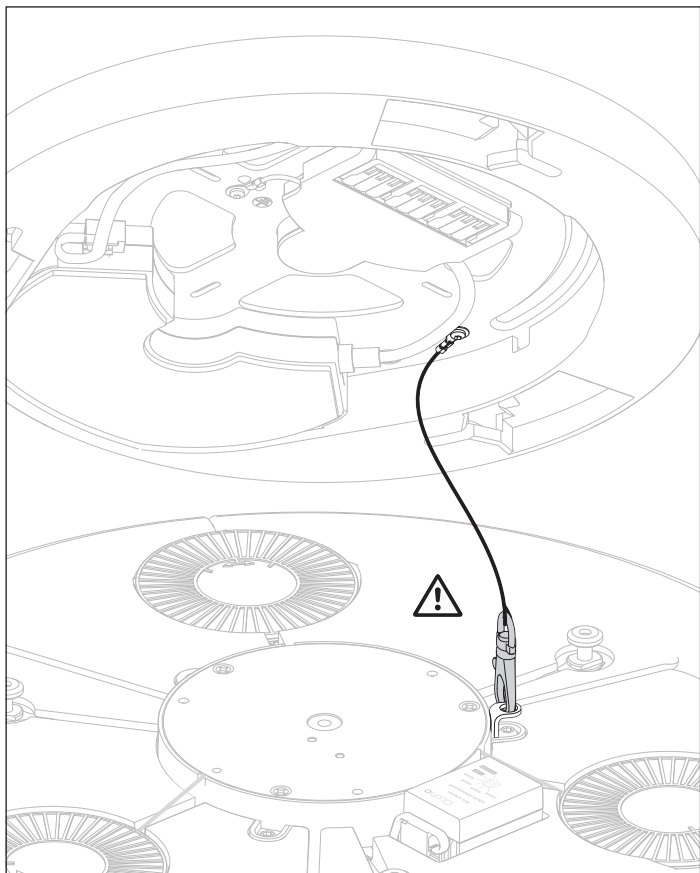
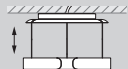

Montage Mito sospeso var up

Mounting Mito sospeso var up

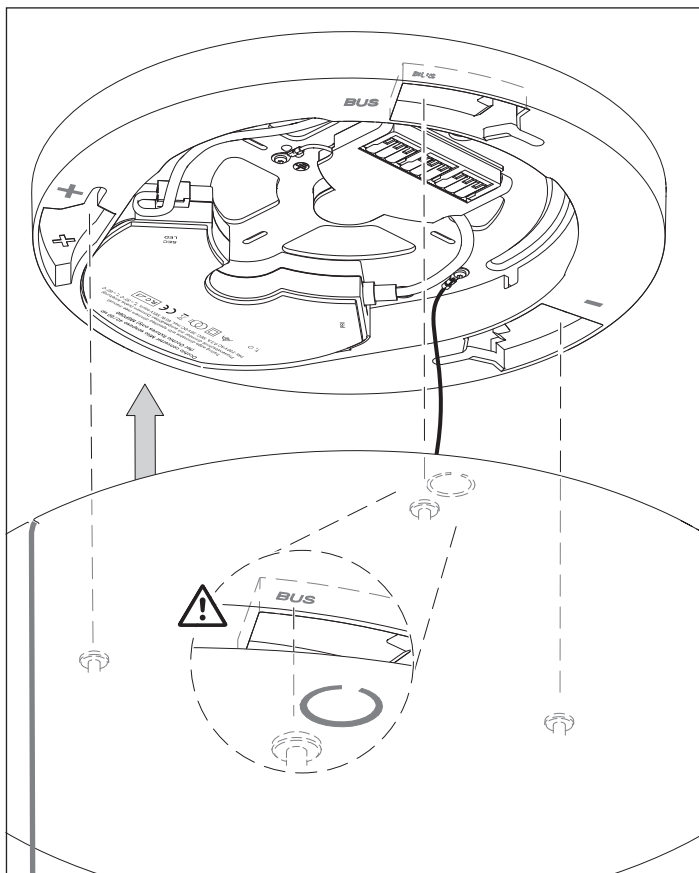

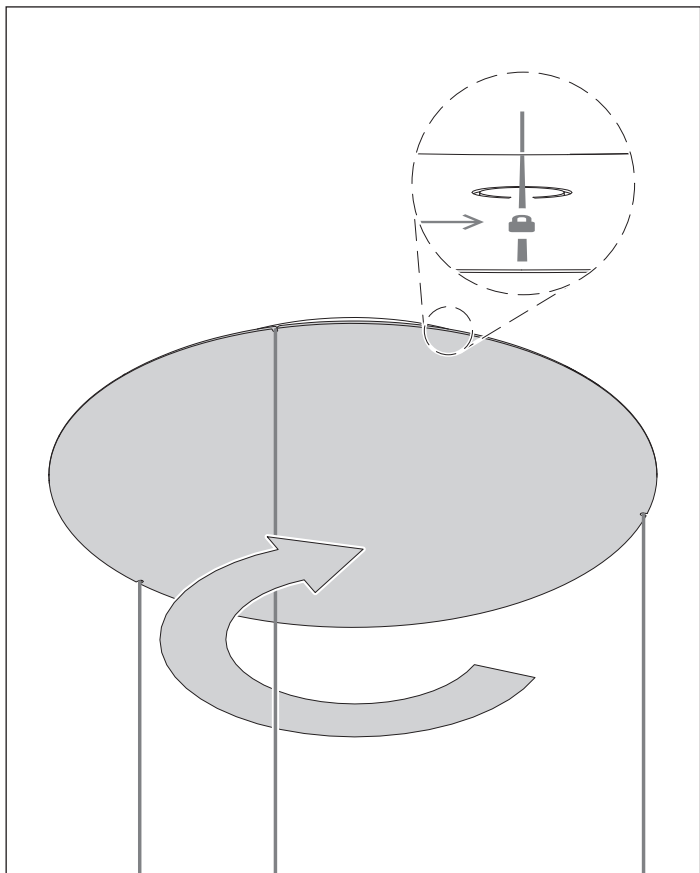
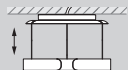

Montage Mito sospeso var up Mounting Mito sospeso var up

Feinjustierung
fine adjustment

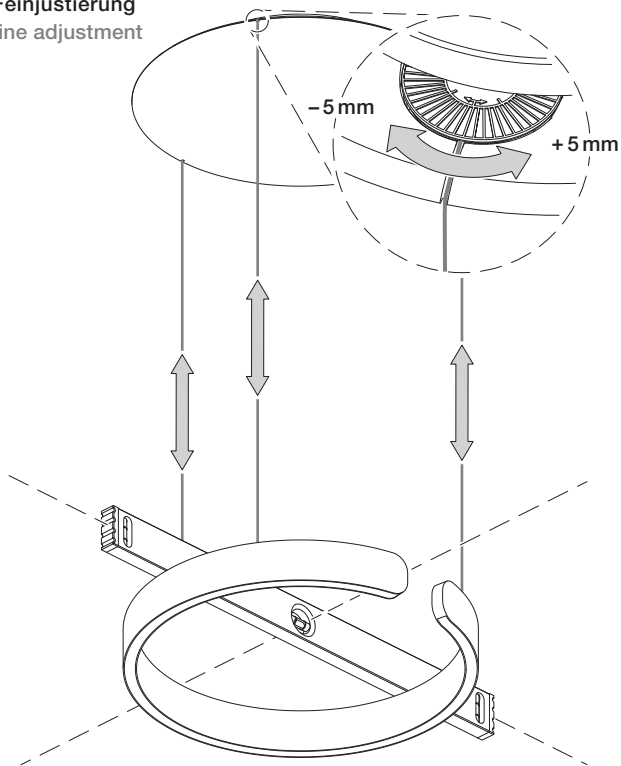

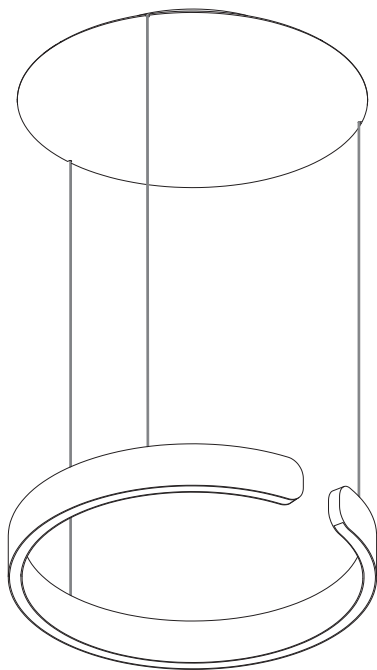
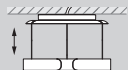

**Die Leuchte ist nun fertig
montiert.**

**The luminaire is now
completely assembled.**

Steuerung mit
der »air« App
(optional)

Control with
the »air« app
(optional)

Steuerung mit der »air« App (optional) Control with the »air« app (optional)



Die Occhio air Produkte lassen sich mit der »air« App einrichten und steuern, sie ist verfügbar für iOS- und Android-Geräte die im jeweiligen Store heruntergeladen werden kann.

Nach dem Öffnen der App, werden die Leuchten und Module, die sich im Empfangsbereich der App befinden, unter **Leuchten in meiner Nähe** angezeigt und können nun eingerichtet und gesteuert werden.

Eine Video-Kurzanleitung kann unter: www.occhio.de/daten/tutorials/air/de aufgerufen werden.





Occhio air products can be set up and controlled with the »air« app; it is available for iOS and Android devices and can be downloaded at the particular store.

After the app is opened, the luminaires and modules that are within the reception range of the app are displayed under **Luminaires near me** and can now be set up and controlled.

A video quick start guide can be called up at www.occhio.de/daten/tutorials/air/en.

Steuerung
mit dem
»air« controller
(optional)

Control
with the
»air« controller
(optional)

Steuerung mit dem »air« controller (optional)

Control with the »air« controller (optional)

Occhio air controller

Intuitiv bedienbare Fernbedienung mit vier programmierbaren Tasten (Einrichtung via Occhio air App). Unabhängig von der App können einzelne Leuchten, Gruppen und Szenen gesteuert werden. Optional mit Wandhalterung erhältlich.

Maximaler Bedienkomfort und umfassende Steuerung via Bluetooth 4.0 (Bluetooth Low Energy). Schalten, dimmen, faden, color tune von einzelnen Leuchten, Gruppen und Szenen.

Occhio air controller

Intuitive remote control with four programmable buttons (setup via Occhio air app). Individual luminaires, groups and scenes can be controlled regardless of the app. Available with optional wall mount.

Maximum ease of use and total control via Bluetooth 4.0 (Bluetooth low energy). Switching, dimming, fading, color tune of individual luminaires, groups and scenes.



Zum Einrichten des Occhio air controllers wird die Occhio air App benötigt. Eine Video-Kurzanleitung kann unter: www.occhio.de/daten/tutorials/air/de aufgerufen werden.

To set up the Occhio air controller, the Occhio air app is required. A video quick start guide can be called up at www.occhio.de/daten/tutorials/air/en.



schalten/switching

 -  einzelne Leuchten, Gruppen, oder Szenen schalten

 -  switch individual luminaires, groups or scenes

dimmen/dim



 - einzelne Leuchten, Gruppen, oder Szenen dimmen

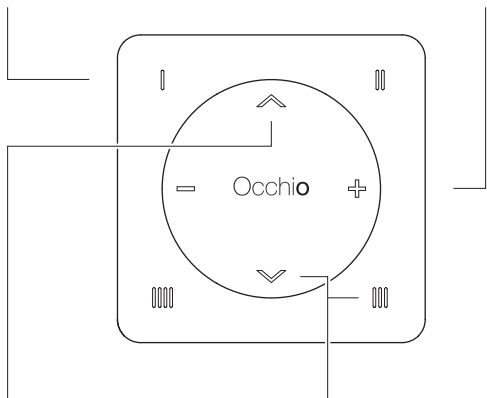

 - dims individual luminaires, groups or scenes



faden*







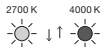

  einzelne Leuchten, Gruppen oder Szenen faden (up/down Verhältnis ändern)

  fades individual luminaires, groups or scenes (change up/down relation)

color tune**



 -  and   Farbtemperatur einzelner Leuchten, Gruppen oder Szenen einstellen

 -  and   adjust color temperature of individual luminaires, groups or scenes

* nur mit beidseitigem Lichtaustritt / only with light outlets on both sides ** nur Mito / only Mito

Anhang

Appendix

Pflegehinweise

Care instructions

Leuchte nur in abgekühltem Zustand reinigen! Zur Reinigung der Leuchte ein trockenes Mikrofasertuch verwenden. Detaillierte Pflegehinweise sind unter www.occhio.de/de/company/faq zu finden.

Always allow the luminaire to cool down before cleaning! To clean the luminaire, use a dry microfibre cloth. Detailed care instructions are available at www.occhio.de/en/company/faq.

Info & Kontakt

Information & contact





Weitere Fragen beantwortet gerne
Ihr Occhio Fachhändler

Your Occhio specialist retailer will
gladly answer any other questions

www.occhio.de
info@occhio.de

Technische Daten

Technische Daten Leuchte

Artikelbezeichnung	Mito sospeso 40 var up, Mito sospeso 60 var up
Abmessungen	Mito sospeso 40 up: head ø 400, H 52 mm, Baldachin ø 380 mm, H 39,5 mm Mito sospeso 60 up: head ø 600, H 52 mm, Baldachin ø 576 mm, H 39,5 mm
Höhenverstellung	Mito sospeso var up: 500 – 2000 mm
Schutzklasse	2
Anschluss	230 V AC
Dimmung	via »touchless control« und Occhio air (optional) oder via Phasenabschnittdim- mer (Liste kompatibler Dimmer: www. occhio.de/dim , Phasenabschnittdimmer und Occhio air nicht kombinierbar)
Material	Aluminium, Stahl, lackiert, eloxiert oder PVD-beschichtet, Kunststoff, optischer Silikon
LED-Leistung	Mito sospeso 40 up: 40 W Mito sospeso 60 up: 60 W
Zulässige Betriebsbedingung	max. 30°C nur im Innenbereich betreiben
Prüfzeichen	IP 20 CE    

Technische Daten Leuchtmittel





Leuchtmittel	Occhio »color tune« LED
Ausführung	LED-board
Lebensdauer	> 50.000 Std.
Energieeffizienzklasse – EEK	A+

Entsorgung

Bei örtlicher Entsorgungsstelle entsorgen. Mito sospeso var up ist recyclebar; RoHS-konform. **Nicht in den Hausmüll geben!**

Technical data

Technical data luminaire

Product designation	Mito sospeso 40 var up, Mito sospeso 60 var up
Dimensions	Mito sospeso 40 up: head \varnothing 400, H 52 mm, canopy \varnothing 380 mm, H 39,5 mm Mito sospeso 60 up: head \varnothing 600, H 52 mm, canopy \varnothing 576 mm, H 39,5 mm
Height adjustment	Mito sospeso var up: 500 – 2000 mm
Safety class	2
Connection	230 V AC
Dimming	via »touchless control« and Occhio air (optional) or via trailing-edge phasecut dimmer (For a list of compatible dimmers, see www.occhio.de/dim_en , trailing-edge phasecut dimmer and Occhio air not combinable)
Material	Aluminium, painted, anodised or PVC-coated steel, plastic, optical silicone
LED power	Mito sospeso 40 up: 40 W Mito sospeso 60 up: 60 W
Permitted operating conditions	max. 30°C for indoor use only
Test symbols	IP 20 CE    

Technical data light source

Light source	Occhio »color tune« LED
Version	LED-board
Lifetime	> 50.000 h
Energy efficiency class – EEC	A+

Disposal

Dispose of at a local disposal site. Mito sospeso var up is recyclable and RoHS compliant. **Do not dispose of with the household waste!**

Occhio

Occhio GmbH
Wiener Platz 7
81667 München
Fon +49-89-44 77 86 30
Fax +49-89-44 77 86 39
info@occhio.de
www.occhio.de



010040429569668510