

## lui alto VOLT Datasheet

LED ceiling spotlight with flat base, cylindrical head and replaceable optics. Version for mounting on a hollow ceiling box or plastering box; connection to 230V AC/50Hz mains voltage; dimmable via trailing-edge phase-cut dimmer\*.

The lui alto is freely rotatable (with stop) and pivotable by up to 45° on the vertical axis. There are two optics to choose from: The zoom optic, which offers a continuous beam of light that is can be set from 20° to 60°, and the lens optic, which has an internal lens combined with various inserts. The optics and optical components can be replaced without any tools, using a simple mechanism. The VOLT light engine is replaceable.

Other versions: lui alto v, lui alto doppio, lui volto (surface-mounted spotlight), lui piano, lui piano v (recessed spotlight)

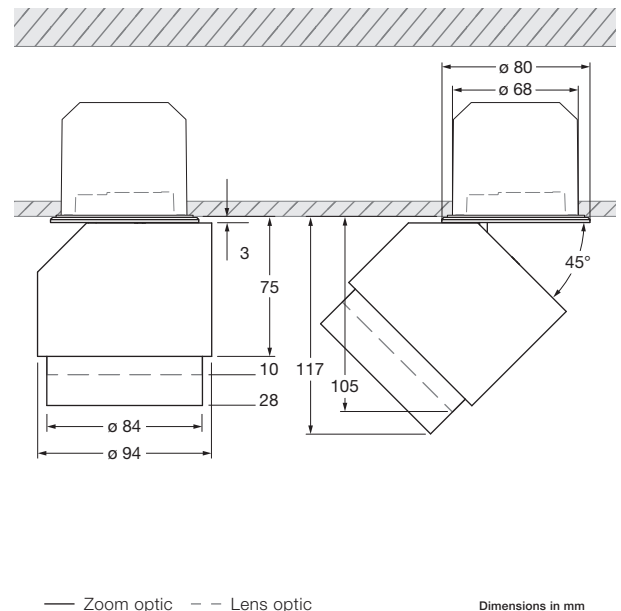

**Materials luminaire**  
aluminium, steel  
chrome-plated, painted  
or anodised, plastic

**Surface head**  
chrome, matt white,  
matt black

**Materials inserts**  
glass, optical plastic

**Surface optic**  
chrome, matt chrome,  
gold, matt white,  
matt black

**Body rotatability**  
360° (with stop)

**Dimming**  
trailing-edge phase cut  
dimmer\*

**Head movability**  
45° (with stop)

**Connection**  
operation at 230V AC/  
50 Hz

**Weight**  
0.85 kg

### VOLT light engine

			perfect color		
<b>Average lifetime</b>	<b>t</b>	> 40.000 hrs	<b>Color rendering index</b>	<b>CRI</b>	Ra 97
<b>Energy efficiency class</b>	<b>EEC</b>	A	<b>Color temperature</b>	<b>T</b>	2700 K
			<b>Recommended use</b>		Residential and commercial
<b>Power</b>	<b>P</b>	13 W**	<b>LED luminous flux</b>	<b>ø</b>	800 lm
<b>Power</b>	<b>P</b>	18 W	<b>LED luminous flux</b>	<b>ø</b>	1000 lm

\* For a list of compatible dimmers, see [www.occhio.de/dim\\_en](http://www.occhio.de/dim_en) \*\* version chrome

## lui alto VOLT Overview inserts

	zoom	C 80	C 60	S 80	S 60	S 40	S 30
lui head							
zoom optic							
lens optic							
small lens medium							
small lens high							
soft edge glass							
clear glass							
fresnel lens							
	zoom	80°, contour	60°, contour	80°, soft	60°, soft	40°, soft	30°, soft

## lui alto VOLT lighting effects

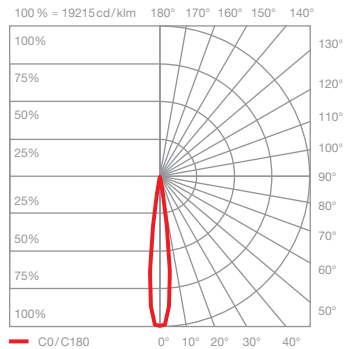
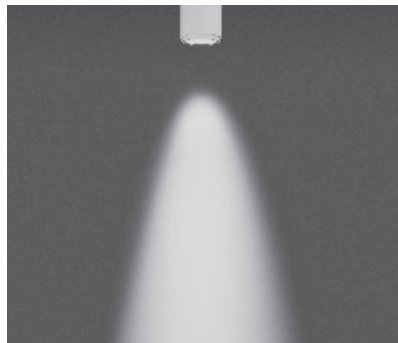

**Z20 soft**  
directed light with soft contour beam angle  
(approx. 20°)

inserts: zoom lens  
soft edge glass

luminous flux: perfect color 18 W 690 lm  
perfect color 13 W 550 lm

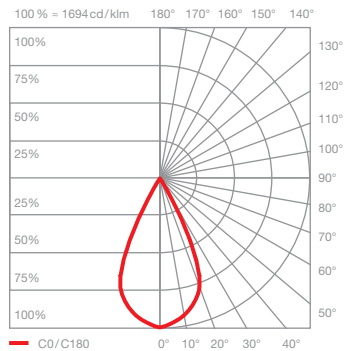
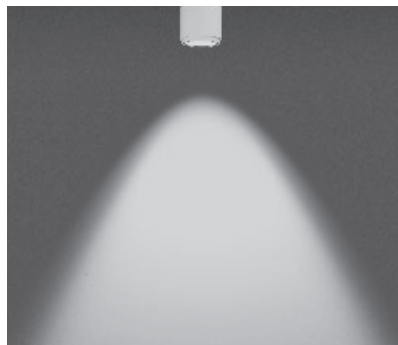

**Z60 soft**  
directed light with soft contour beam angle  
(approx. 60°)

inserts: zoom lens  
soft edge glass

luminous flux: perfect color 18 W 690 lm  
perfect color 13 W 550 lm

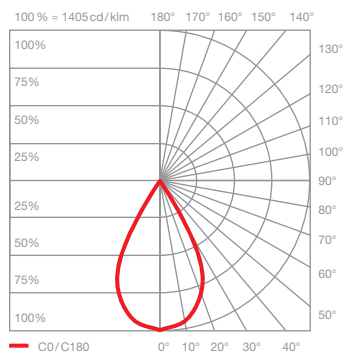
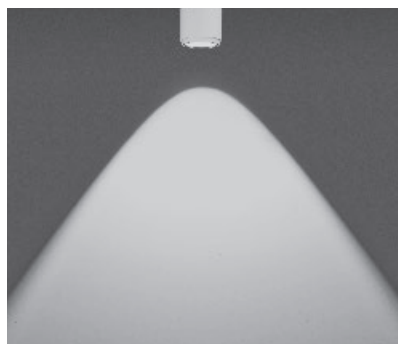

**C80 contour**  
directed light with contour beam angle  
(approx. 80°)

inserts: lens optic  
small lens medium  
clear glass

luminous flux: perfect color 18 W 760 lm  
perfect color 13 W 610 lm

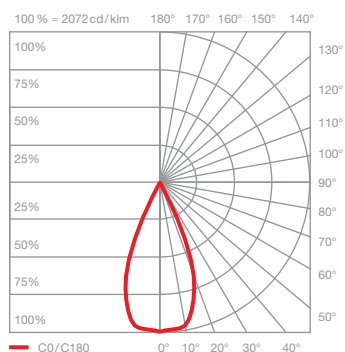

**C60 contour**  
directed light with contour beam angle  
(approx. 60°)

inserts: lens optic  
small lens high  
clear glass

luminous flux: perfect color 18 W 750 lm  
perfect color 13 W 600 lm

## lui alto VOLT lighting effects

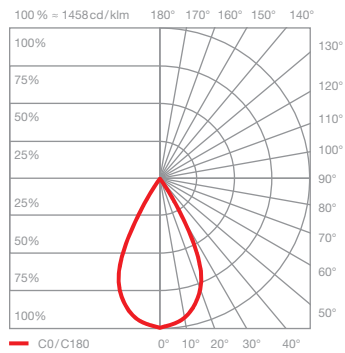

### S80 soft

directed light with soft contour beam angle (approx. 80°)

inserts: lens optic  
small lens medium  
soft edge glass

luminous flux: perfect color 18 W 750 lm  
perfect color 13 W 600 lm

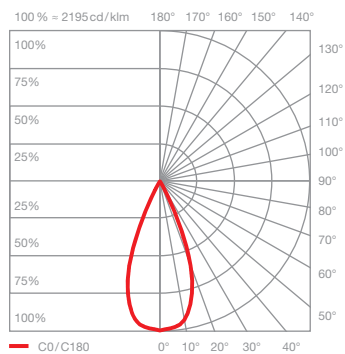
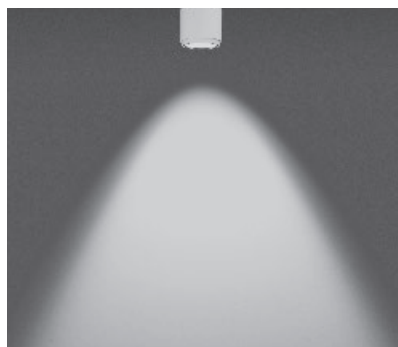

### S60 soft

directed light with soft contour beam angle (approx. 60°)

inserts: lens optic  
small lens high  
soft edge glass

luminous flux: perfect color 18 W 750 lm  
perfect color 13 W 600 lm

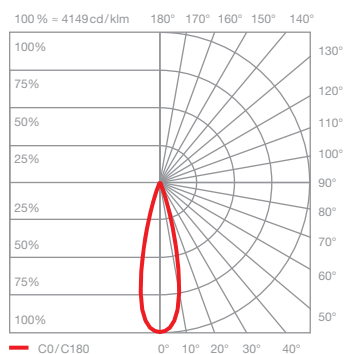
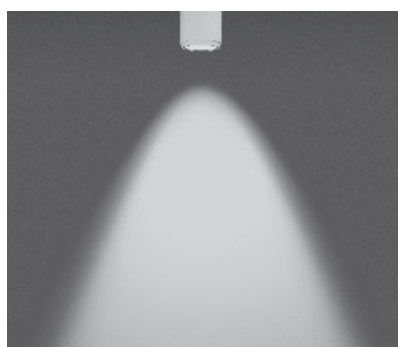

### S40 soft

directed light with soft contour beam angle (approx. 40°)

inserts: lens optic  
small lens medium  
fresnel lens

luminous flux: perfect color 18 W 630 lm  
perfect color 13 W 510 lm

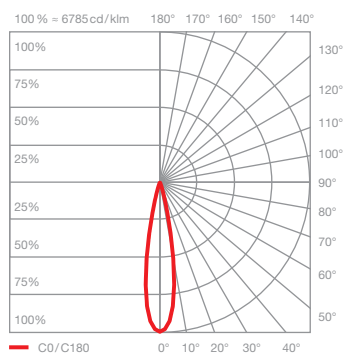

### S30 soft

directed light with soft contour beam angle (approx. 30°)

inserts: lens optic  
small lens high  
fresnel lens

luminous flux: perfect color 18 W 660 lm  
perfect color 13 W 530 lm