

lui alto track VOLT Datasheet

LED bus bar spotlight with cylindrical head and replaceable optics. Version for 3-phase EUTRAC bus bar; connection to 230V AC/50Hz mains voltage; dimmable via trailing-edge phase-cut dimmer*.

The lui alto track VOLT is freely rotatable (with stop) and pivotable by up to 55° on the vertical axis. There are two optics to choose from: The zoom optic, which offers a continuous beam of light that is can be set from 20° to 60°, and the lens optic, which has an internal lens combined with various inserts. The optics and optical components can be replaced without any tools, using a simple mechanism. The VOLT light engine is replaceable.

Other versions: lui alto, lui alto v, lui alto doppio, lui volto (surface-mounted spotlight), lui piano, lui piano v (recessed spotlight)

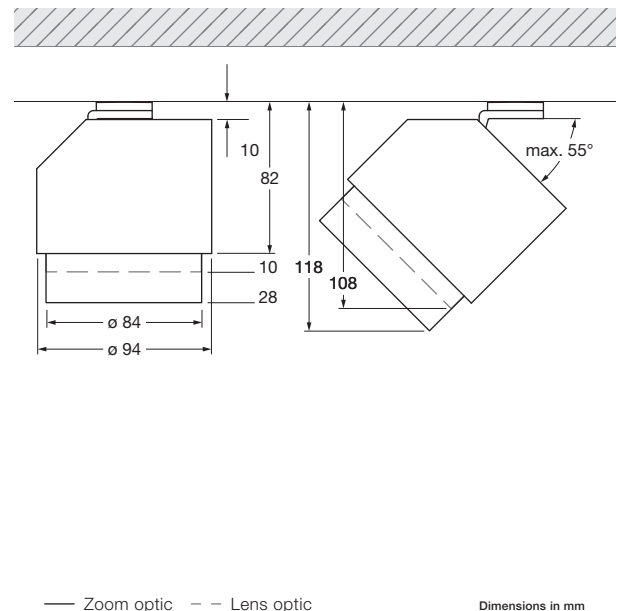
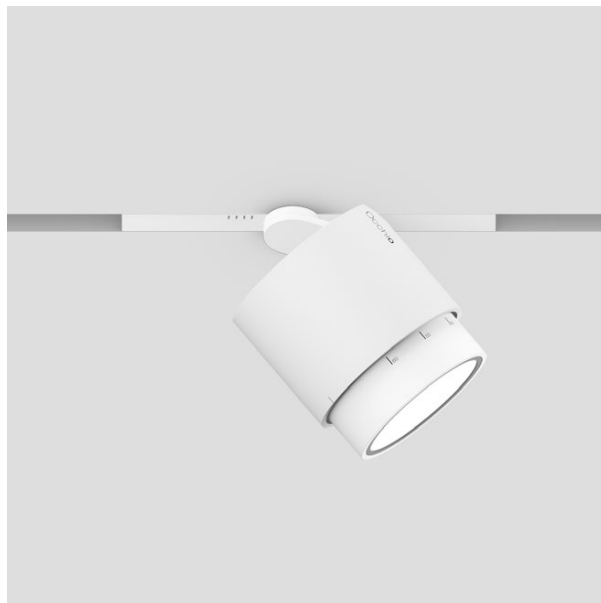

Materials luminaire
aluminium, steel
chrome-plated, painted
or anodised, plastic

Surface track adapter
silver, matt white,
matt black

Surface optic
chrome, matt chrome,
gold, matt white,
matt black

Body rotatability
360° (with stop)

Dimming
trailing-edge phase cut
dimmer*

Materials inserts
glass, optical plastic

Surface head
chrome, matt white,
matt black

Head movability
55° (with stop)

Connection
operation at 230V AC/
50 Hz

Weight
0.85 kg

VOLT light engine

			perfect color		
Average lifetime	t	> 40.000 hrs	Color rendering index	CRI	Ra 97
Energy efficiency class	EEC	A	Color temperature	T	2700 K
			Recommended use		Residential and commercial
Power	P	13 W**	LED luminous flux	ø	800 lm
Power	P	18 W	LED luminous flux	ø	1000 lm

* For a list of compatible dimmers, see www.occhio.de/dim_en ** version chrome

lui alto track VOLT Overview inserts

	zoom	C 80	C 60	S 80	S 60	S 40	S 30
lui head							
zoom optic							
lens optic							
small lens medium							
small lens high							
soft edge glass							
clear glass							
fresnel lens							
	zoom	80°, contour	60°, contour	80°, soft	60°, soft	40°, soft	30°, soft

lui alto track VOLT lighting effects

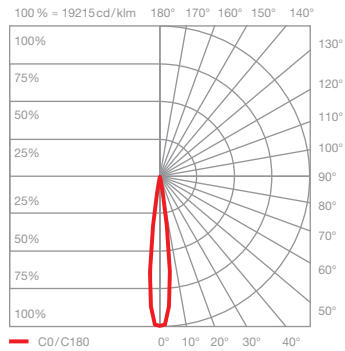
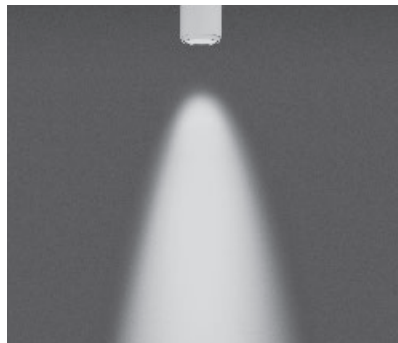

Z20 soft
directed light with soft contour beam angle
(approx. 20°)

inserts: zoom lens
soft edge glass

luminous flux: perfect color 18W 690lm
perfect color 13W 550lm

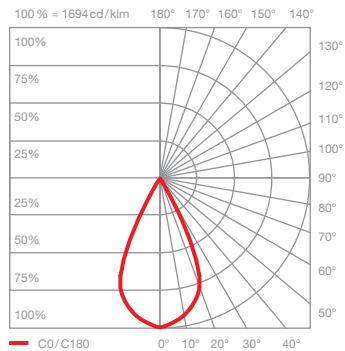
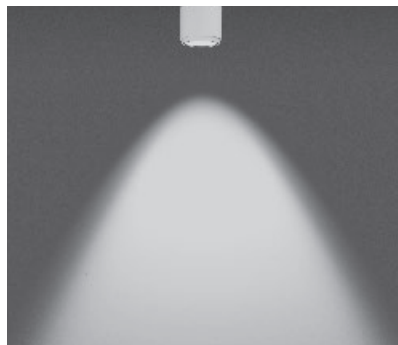

Z60 soft
directed light with soft contour beam angle
(approx. 60°)

inserts: zoom lens
soft edge glass

luminous flux: perfect color 18W 690lm
perfect color 13W 550lm

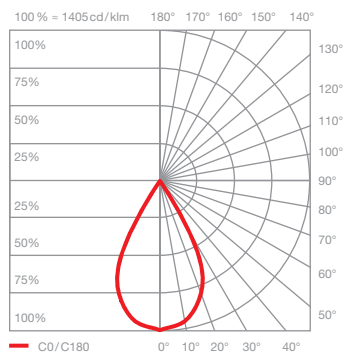
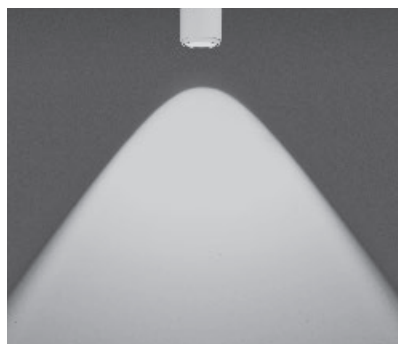

C80 contour
directed light with contour beam angle
(approx. 80°)

inserts: lens optic
small lens medium
clear glass

luminous flux: perfect color 18W 760lm
perfect color 13W 610lm

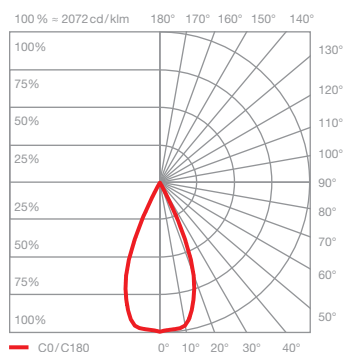

C60 contour
directed light with contour beam angle
(approx. 60°)

inserts: lens optic
small lens high
clear glass

luminous flux: perfect color 18W 750lm
perfect color 13W 600lm

lui alto track VOLT lighting effects

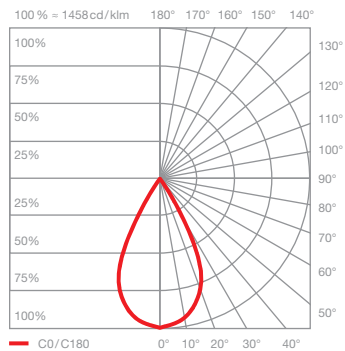
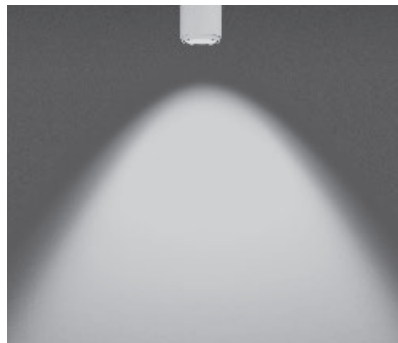

S80 soft

directed light with soft contour beam angle (approx. 80°)

inserts: lens optic
small lens medium
soft edge glass

luminous flux: perfect color 18 W 750 lm
perfect color 13 W 600 lm

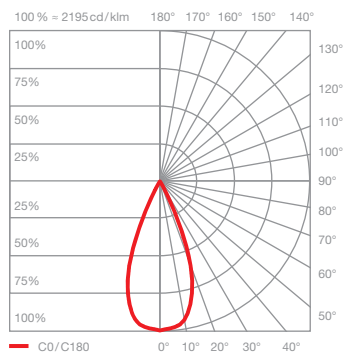
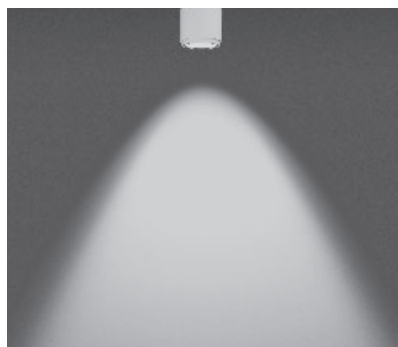

S60 soft

directed light with soft contour beam angle (approx. 60°)

inserts: lens optic
small lens high
soft edge glass

luminous flux: perfect color 18 W 750 lm
perfect color 13 W 600 lm

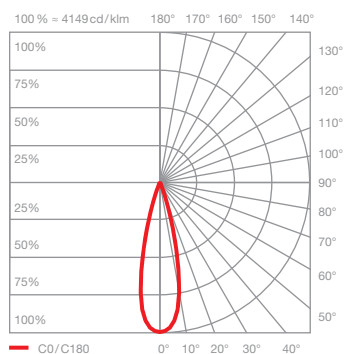
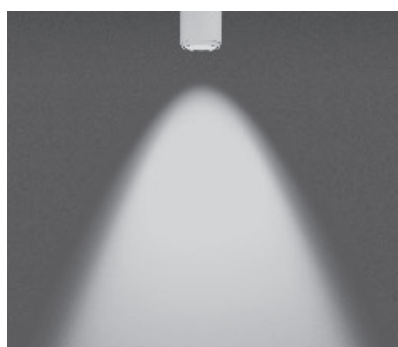

S40 soft

directed light with soft contour beam angle (approx. 40°)

inserts: lens optic
small lens medium
fresnel lens

luminous flux: perfect color 18 W 630 lm
perfect color 13 W 510 lm

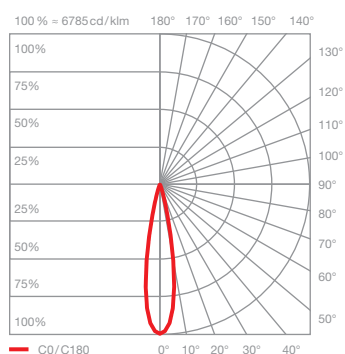

S30 soft

directed light with soft contour beam angle (approx. 30°)

inserts: lens optic
small lens high
fresnel lens

luminous flux: perfect color 18 W 660 lm
perfect color 13 W 530 lm