

io verticale »cc« datasheet

LED wall spotlight with double-sided light output, spherical head and lens optics. The light is freely rotatable (with stop), the lighting effects can be changed at any time through optional inserts using a simple mechanism, dichroic colour filter can be additionally inserted. Surface combinations can be configured.

Version for fitting on hollow ceiling box or wall box with remote power supply unit; connection to external power source (driver). Power 18 W (13 W version chrome, rose gold, bronze); dimmable via customer-supplied dimmable power supply unit. The Occhio light module is replaceable.

Other versions: io alto v, io giro, io giro doppio, io piano, io piano v

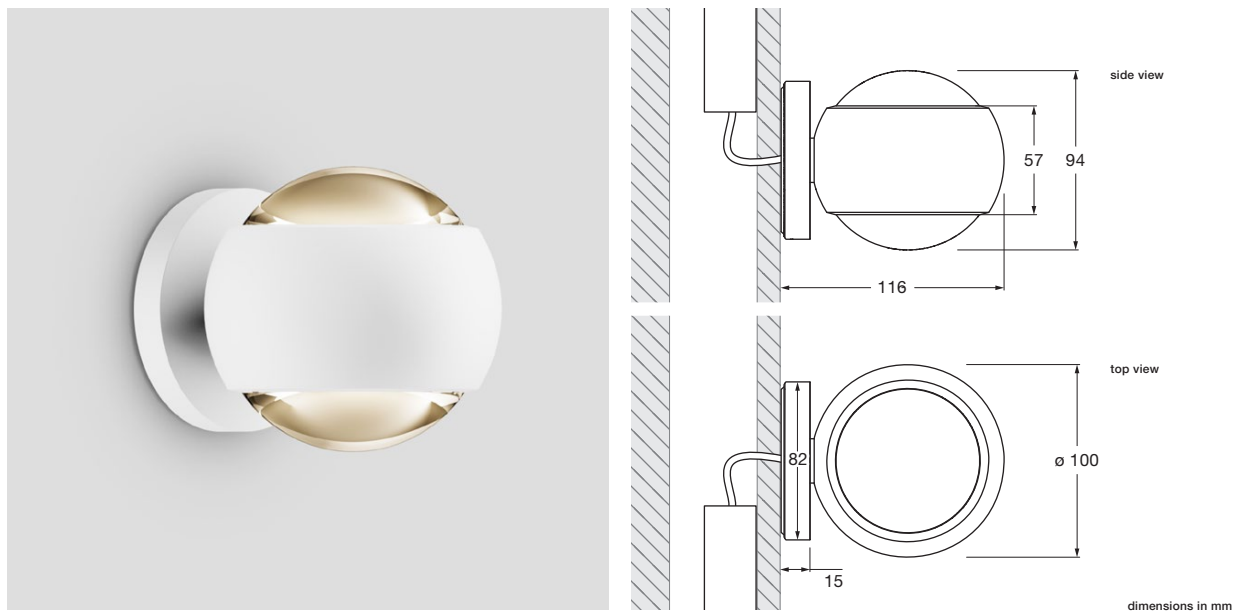

technical data io verticale »cc«

properties	material	aluminium, chrome-plated, painted, anodised or PVC-coated, plastic, glass, optical plastic		
	turning range head	360° (with stop)		
	weight	1.0 kg		
surface	head	matt gold (cover matt white or matt black), rose gold (cover matt black), bronze (cover schwarz matt), chrom, weiß matt, schwarz matt		
Occhio light module	average life time	> 50.000 hrs		
	energy efficiency class	A+ / A++		
	power	18 W (13 W version chrome, rose gold, bronze)		
	color rendering index	perfect color; CRI Ra 97	high flux; CRI Ra 85	
	color temperature	2700, 3000 K	3000, 3500, 4000 K	
	recommended use	residential and commercial	commercial	
electricity	dimming	with suitable power supply unit		
	power supply unit	max. 500 mA const. / > 36 V DC (350 mA version chrome, rose gold, bronze)		
	permitted operating conditions	max. 30°C for indoor use only		



io verticale » cc « lighting effects

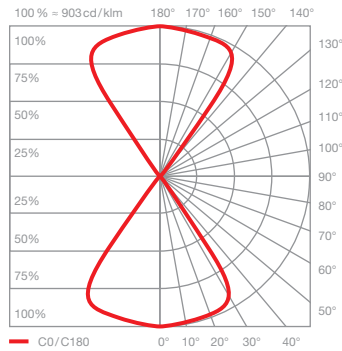
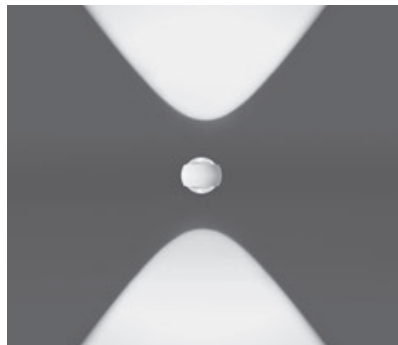

io verticale D

directed light with contour beam angle
(approx. 80°)*

inserts: lens

luminous flux:	perfect color	18 W	1650 lm
	high flux	18 W	2200 lm
	perfect color	13 W	1100 lm
	high flux	13 W	1650 lm

*without aperture

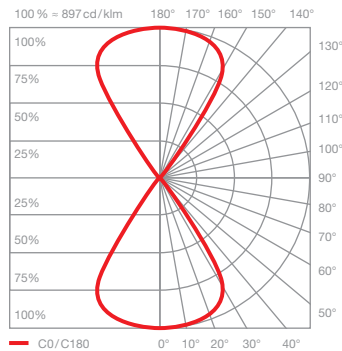
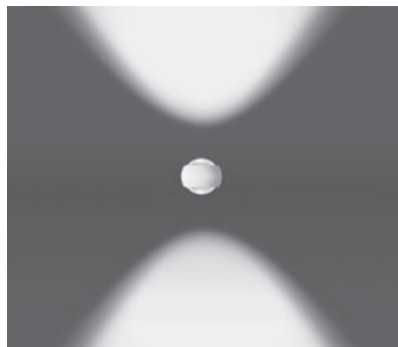

io verticale D with soft edge glass

directed light with soft contour beam angle
(approx. 80°)

inserts: lens
soft edge glass**

luminous flux:	perfect color	18 W	1460 lm
	high flux	18 W	1950 lm
	perfect color	13 W	980 lm
	high flux	13 W	1460 lm

** Included in the scope of delivery

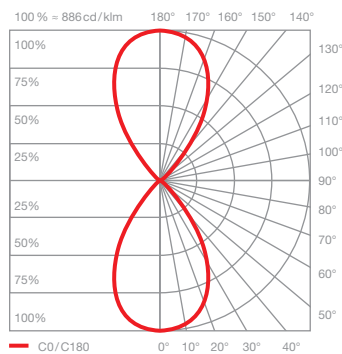
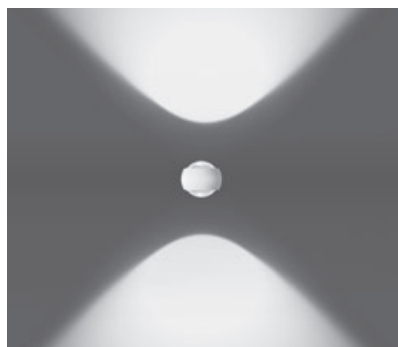

io verticale D with satinised glass

directed light with soft contour beam angle
(approx. 100°)

inserts: lens
satinised glass

luminous flux:	perfect color	18 W	1200 lm
	high flux	18 W	1610 lm
	perfect color	13 W	800 lm
	high flux	13 W	1200 lm

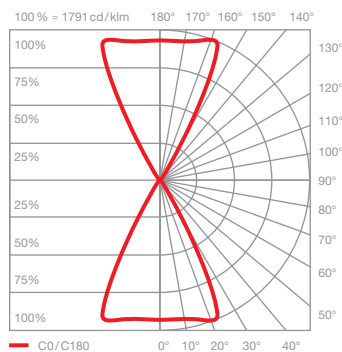
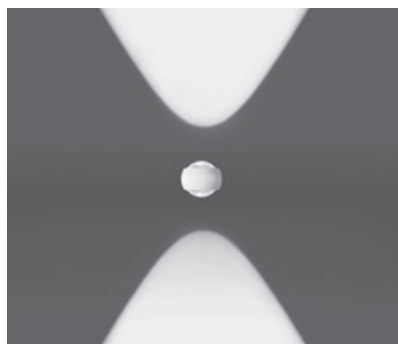

io verticale D with fresnel lens

bundled light
beam angle approx. 60°

inserts: lens
fresnel lens

luminous flux:	perfect color	18 W	1360 lm
	high flux	18 W	1810 lm
	perfect color	13 W	900 lm
	high flux	13 W	1360 lm

connection diagram

up / downlight simultaneously

max. 500 mA (max. 350 mA chrome,
rose gold, bronze)



up / downlight individually

max. 2 × 250 mA (max. 2 × 175 mA chrome,
rose gold, bronze)

