

io piano v »cc« datasheet

LED ceiling recessed spotlight as a downlight with spherical head and lens optics; mounting flush with ceiling for hollow ceilings or solid ceilings with ceiling box.

Version with remote power supply unit; connection to external power source (driver). Dimmable via customer-supplied dimmable power supply unit. Choice of several variants for different installation solutions. Covers that are held in place magnetically are used in ceiling-mounted versions and in frameless models which have a mounting plate for mounting to hollow ceilings.

Lighting effect through optional inserts can be changed at any time using a simple mechanism; the Occhio light module is replaceable.

Other versions: io alto v, io giro, io giro doppio, (surface-mounted spotlight), io piano (recessed spotlight).

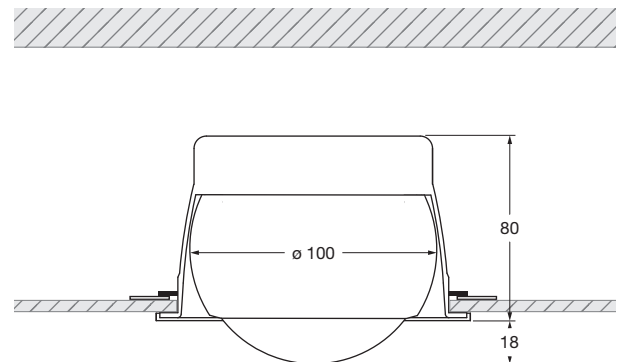
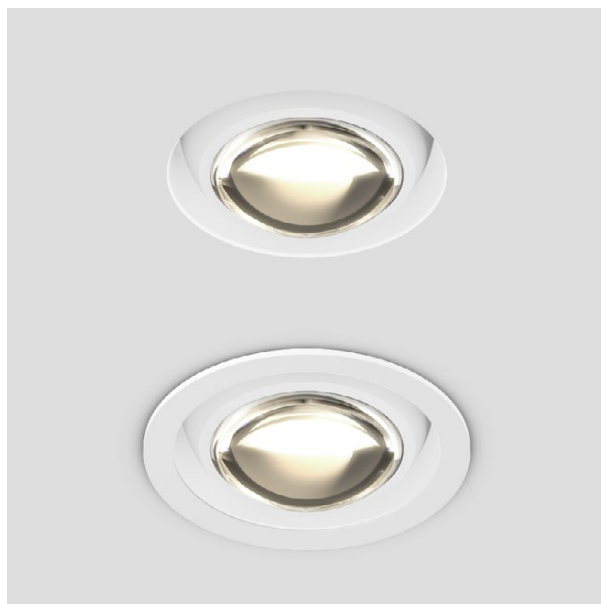

dimensions in mm

technical data io piano v »cc«

properties	material	aluminium chrome-plated, painted or anodised, plastic, glass, optical plastic		
	weight	1.10 kg		
surface	head	matt gold, rose gold, bronze, chrome, glossy white, matt white, glossy black, matt black		
	tube	matt white, matt black		
	cover	matt gold, rose gold, bronze, chrome, matt white, matt black		
Occhio light module	average life time	> 50.000 hrs		
	energy efficiency class	A++ / A+		
	power	13 W		
	color rendering index	perfect color; CRI Ra 97	high flux; CRI Ra 85	
	color temperature	2700 K, 3000 K	3000 K, 3500 K, 4000 K	
	recommended use	residential and commercial	commercial	
electricity	dimming	dimmable with suitable power supply unit		
	power supply unit	max. 350 mA const. / >36 V DC		
	permitted operating conditions	max. 30°C for indoor use only		



io piano v »cc« mounting options

io piano v
ø head 100 mm, H 50 mm

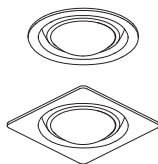

mounting tube with cover

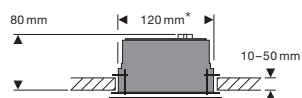

hollow ceiling

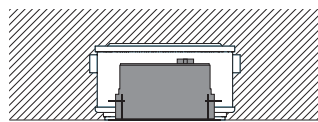

concrete ceiling
(Kaiser HaloX 180 with mineral-fibre board)
driver max. L 130 mm x W 30 mm



cover

io piano v seamless
io piano v
ø head 100 mm, H 50 mm

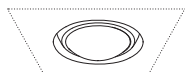

mounting board for seamless mounting

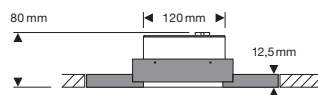

hollow ceiling
(mineral-fibre board with holding ring)

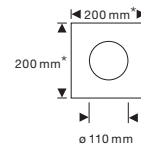

*cut-out dimensions

io piano v »cc« lighting effects

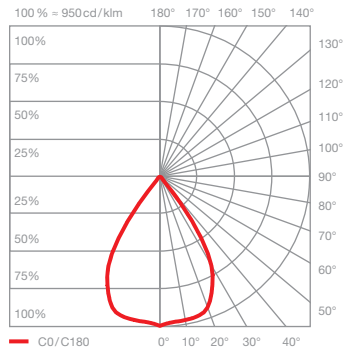
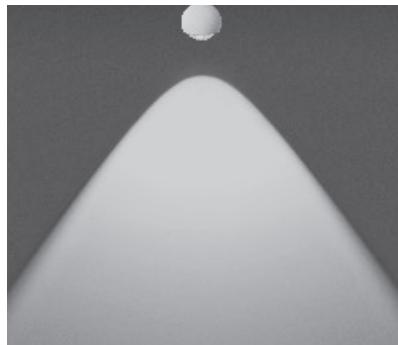

io C
directed light with contour beam angle
(approx. 80°)*

inserts: lens

luminous flux: perfect color 13W 1010lm
high flux 13W 1460lm

*without aperture

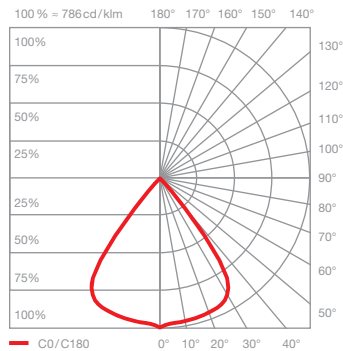
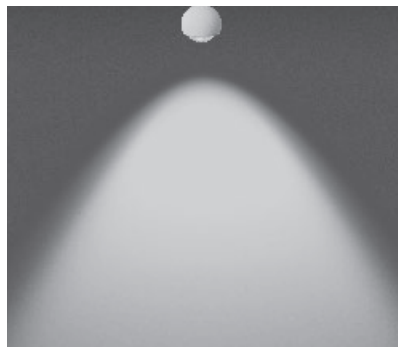

io C with soft edge glass
directed light with soft contour beam angle
(approx. 80°)

inserts: lens
soft edge glass

luminous flux: perfect color 13W 900lm
high flux 13W 1300lm

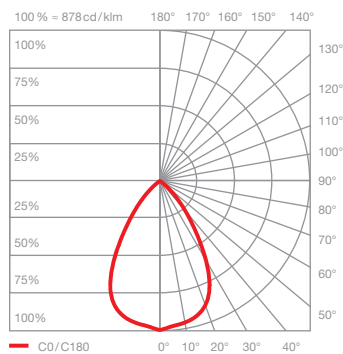
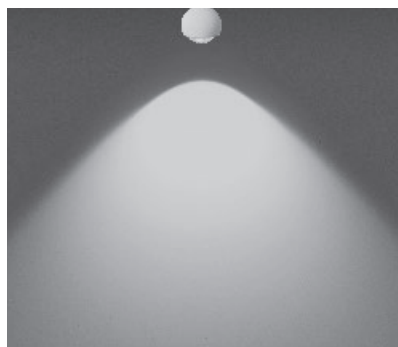

io C with satinised glass
directed light with soft contour beam angle
(approx. 100°)

inserts: lens
satinised glass

luminous flux: perfect color 13W 740lm
high flux 13W 1070lm

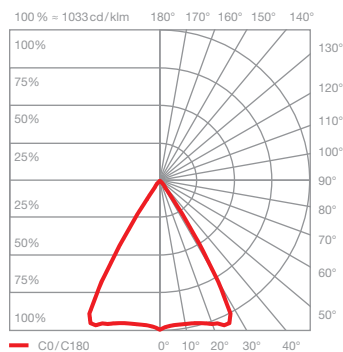
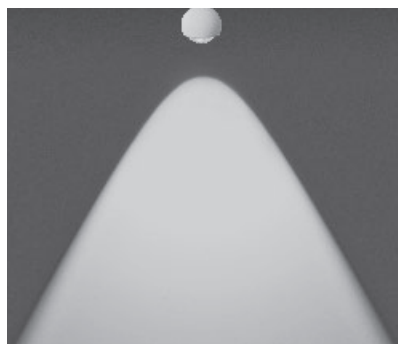

io C with fresnel lens
bundled light
beam angle approx. 60°

inserts: lens
fresnel lens

luminous flux: perfect color 13W 830lm
high flux 13W 1210lm