

Più piano in HV cutsheet

The Più lighting system includes recessed mounted spotlights (piano and piano in), surface mounted spotlights (alto and alto²) and track lights.

Thanks to the unique ball joint principle the Più spotlight heads are freely alignable up to an angle of 30° (Più piano 30°, Più piano in 20°). Different versions are available for diverse recessing solutions. The magnetically fixed cover rings are characteristic of these recessed ceiling versions. The seamless models are available with mounting board or for assembly on panels accessible from the rear.

The various optical components (inserts) can be exchanged and reassembled at any time using a simple mechanism.

The Occhio 'Smart Source' concept offers a free choice of the 4 lightsources: mains voltage halogen (HV), low voltage halogen (NV), metal halide halogen (CDM) and „next generation“ LED.

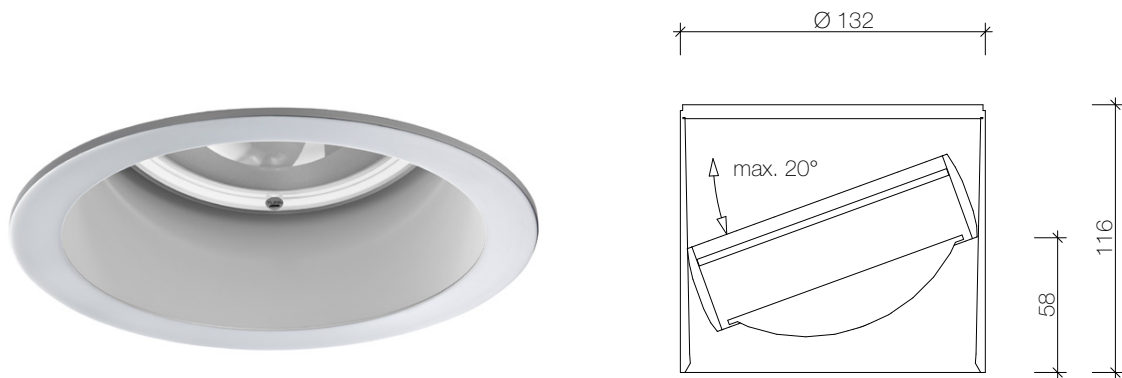

materials light fixture
aluminium, brass, steel
chrome-plated or
painted

materials inserts
optical plastic, glass

surface head
chrome, matt chrome,
glossy black (nero),
matt black,
glossy white (bianco),
matt white

surface tube
matt black, matt white

surface cover
chrome, matt chrome,
glossy black (nero),
matt black,
glossy white (bianco),
matt white

rotation body
360°

movability head
20° (with stop)

weight
max. 1,2 kg

lighting effects
see cutsheet page 2

dimming function
with standard trailing- or
leading-edge dimmers

ECG
not necessary
operating voltage
230 V AC

light source HV

power	P	60 W	48 W
luminous flux	ø	980 lm	740 lm
efficiency	η	16 lm/W	15 lm/W
average lifetime	t	2000 h	

color temperature	T	2800 K
color rendering index	CRI	Ra 100
efficiency class	EEC	D
socket		G9
Osram item		Halopin Eco

recommended usage residential

Più piano in lighting effects HV

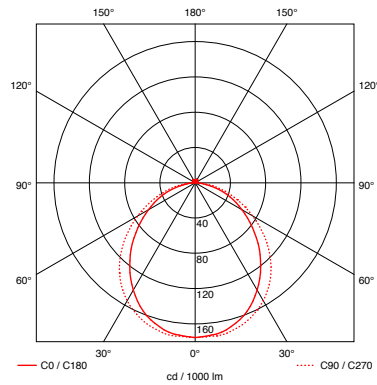
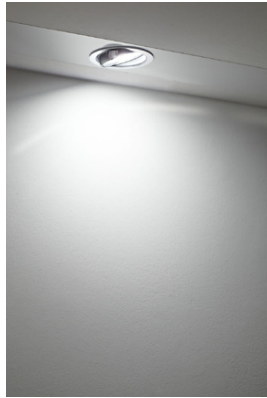

Più B

diffused light
luminous efficiency approx. 49%

insert: satinised glass

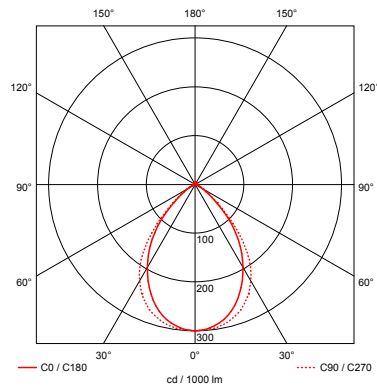
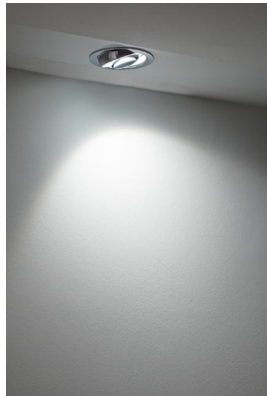

Più C with satinised glass

scattered light
with soft widening of beam angle
luminous efficiency approx. 53 %
beam angle approx. 90°

insert: satinised glass
lens

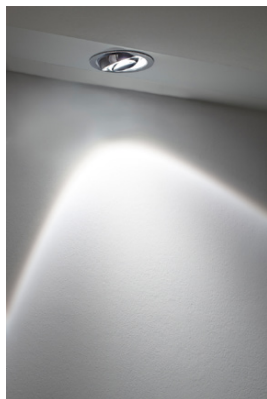

Polardiagramm similar to Più C

Più C with soft edge glass

directed light
with soft contour of the beam angle
luminous efficiency approx. 54 %
beam angle approx. 80°

insert: soft edge glass
lens

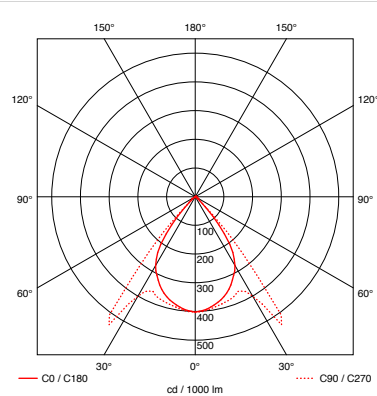
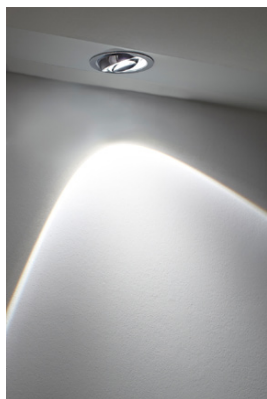

Più C



directed light
luminous efficiency approx. 59 %
beam angle approx. 80°

insert: lens

Più piano in HV article numbers

color code

complete article number with
color code ___(head + tube)













tube (inside) — 
head — 

<u>C</u>	<u>C</u>	head	tube
<u>M</u>	<u>M</u>	chrome	<u>W</u> matt white
<u>C</u>	<u>B</u>	matt chrome	<u>S</u> matt black
<u>M</u>	<u>W</u>	glossy white (bianco)	
<u>C</u>	<u>N</u>	matt white	
<u>M</u>	<u>S</u>	glossy black (nero)	
		matt black	











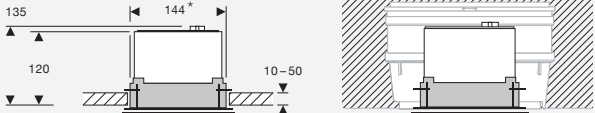

HV halogen

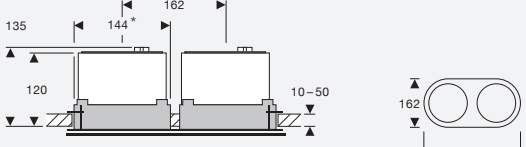
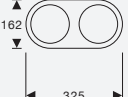
mains voltage halogen Eco G9

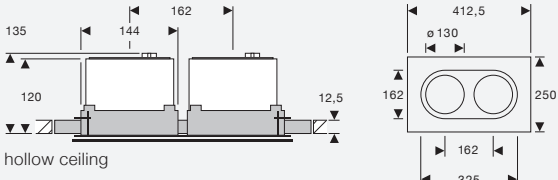
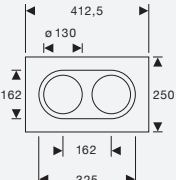
max. 60 W (excl. bulb)

head	Più piano in HV		article no.	
B 	B 	satinised glass diffuse	1P2289 __ please add color code	
C 	C 	lens 80°	1P2288 __	
inserts optional	 filter red	8K602R	 satinised glass	8K6040
	 filter green	8K602G	 soft edge glass	8K6035
	 filter blue	8K602B		
	 filter yellow	8K602Y		
	 filter magenta	8K602M		only for version C
light source + don't forget to order	 HV halogen Eco G9 48 W	5D0048C		
	 HV halogen Eco G9 60 W	5D0060C		

Più piano in mounting options (cover / seamless)

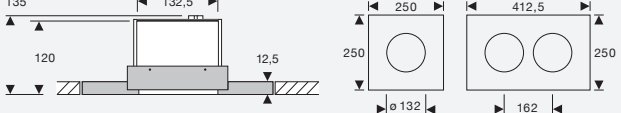
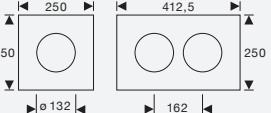
mount.	 mounting ring + cover	article no.
<p>+ don't forget to order</p>	 <p>chrome 1M 11 00 C matt chrome 1M 11 00 M glossy white (bianco) 1M 11 00 B matt white 1M 11 00 W glossy black (nero) 1M 11 00 N matt black 1M 11 00 S</p>	 <p>hollow ceiling</p> <p>concrete ceiling (Kaiser KompaX3 with 50 mm adapter ring and mineral-fibre board)</p> 
	 <p>chrome 1M 12 00 C matt chrome 1M 12 00 M glossy white (bianco) 1M 12 00 B matt white 1M 12 00 W glossy black (nero) 1M 12 00 N matt black 1M 12 00 S</p>	 <p>hollow ceiling</p> 
	 <p>doppio mounting board + cover</p> <p>chrome 1M 13 00 C matt chrome 1M 13 00 M glossy white (bianco) 1M 13 00 B matt white 1M 13 00 W glossy black (nero) 1M 13 00 N matt black 1M 13 00 S</p>	 <p>hollow ceiling</p> 
	 <p>panel seamless</p> <p>holding ring for panel 1M 30 00</p>	 <p>hollow ceiling</p> <p>concrete ceiling plastered, no fair-faced concrete (Kaiser KompaX3 with 50 mm adapter ring and mineral-fibre board)</p> 
	 <p>fitting ring 1M 20 00</p> <p>(for KompaX3 installation housings)</p>	
	 <p>mounting board seamless</p> <p>mounting board seamless 1M 21 00</p>  <p>doppio mounting board seamless 1M 22 00</p>	 <p>hollow ceiling</p> <p>concrete ceiling plastered, no fair-faced concrete (Kaiser KompaX3 with 50 mm adapter ring and mineral-fibre board)</p> 

*cut-out dimensions