

Più alto HV cutsheet

The Più lighting system includes recessed mounted spotlights (piano and piano in), surface mounted spotlights (alto and alto²) and track lights.

Thanks to a special attachment technique Più alto and alto² spotlights are rotatable 360° and pivotable 45° thanks to a hidden joint. However they can also be fixed in a vertical position for downlight use only.

The various optical components (inserts) can be exchanged and reassembled at any time using a simple mechanism.

The Occhio 'Smart Source' concept offers a free choice of the 4 lightsources: mains voltage halogen (HV), low voltage halogen (NV), metal halide halogen (CDM) and „next generation“ LED.

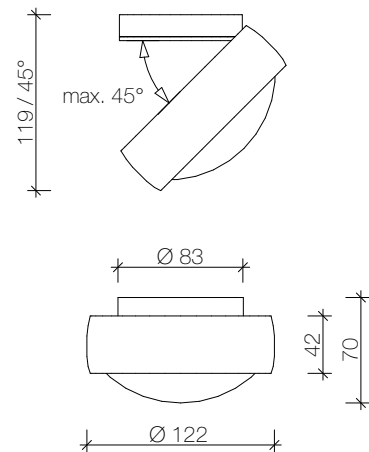

materials light fixture
aluminium, brass, steel
chrome-plated or
painted

materials inserts
optical plastic, glass

surface head
chrome, matt chrome,
glossy black (nero),
matt black,
glossy white (bianco),
matt white

surface body
chrome, matt chrome

rotation body
360° (with stop)

movability head
45° (with stop)

weight
max. 0,9 kg

lighting effects
see cutsheet page 2

dimming function
with standard trailing- or
leading-edge dimmers

ECG
not necessary
operating voltage
230 V AC

light source HV

power	P	60 W	48 W
luminous flux	ø	980 lm	740 lm
efficiency	η	16 lm/W	15 lm/W
average lifetime	t	2000 h	

color temperature	T	2800 K
color rendering index	CRI	Ra 100
efficiency class	EEC	D
socket		G9
Osram item		Halopin Eco

recommended usage residential

Più alto lighting effects HV

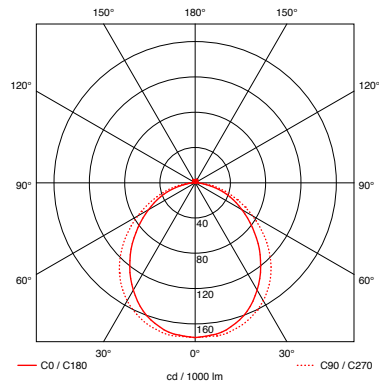
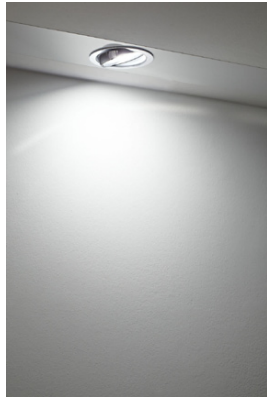

Più B

diffused light
luminous efficiency approx. 49%

insert: satinised glass

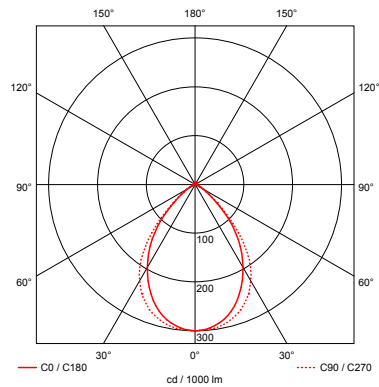
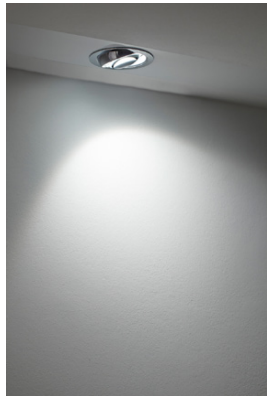

Più C with satinised glass

scattered light
with soft widening of beam angle
luminous efficiency approx. 53 %
beam angle approx. 90°

insert: satinised glass
 lens

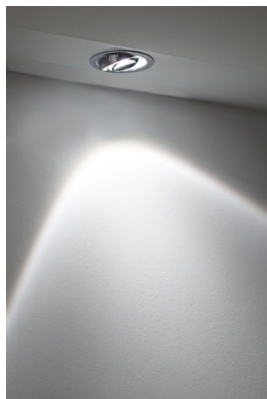

Polardiagramm similar to Più C

Più C with soft edge glass

directed light
with soft contour of the beam angle
luminous efficiency approx. 54 %
beam angle approx. 80°

insert: soft edge glass
 lens

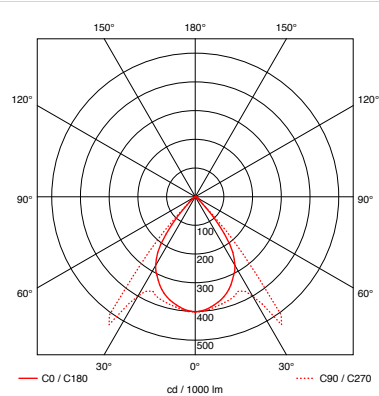
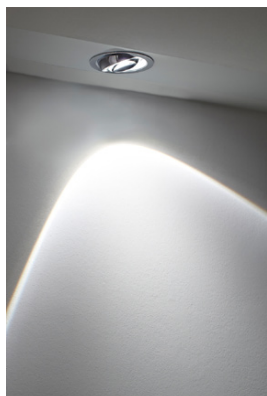

Più C



directed light
luminous efficiency approx. 59 %
beam angle approx. 80°

insert: lens

Più alto HV article numbers

color code















complete article number with
color code: __

base — 
head — 

<u>C</u> <u>C</u>	base	head
<u>M</u> <u>M</u>	chrome	chrome
<u>C</u> <u>B</u>	matt chrome	matt chrome
<u>M</u> <u>W</u>	chrome	glossy white (bianco)
<u>C</u> <u>N</u>	matt chrome	matt white
<u>M</u> <u>S</u>	chrome	glossy black (nero)
	matt chrome	matt black

HV halogen

mains voltage halogen Eco G9
max. 60 W (excl. bulb)

head	Più alto HV		article no.	
B 	B 	satinised glass diffuse	1A1289 __ please add color code	
C 	C 	lens 80°	1A1288 __	
inserts optional	 filter red	8K602R	 satinised glass	8K6040
	 filter green	8K602G	 soft edge glass	8K6035
	 filter blue	8K602B		
	 filter yellow	8K602Y		
	 filter magenta	8K602M		only for version C
light source + don't forget to order	 HV halogen Eco G9 48 W	5D0048C		
	 HV halogen Eco G9 60 W	5D0060C		
accessories	 loop-in loop-out wiring set	1Z2280 - P	 cavity box	9Z2200