



AXO[®] 2013-2015
LIGHT

Collezione di sospensioni, plafoniere ad una o tre luci in ABS bianco ad iniezione disponibili nelle versioni esterno cromo/interno bianco, esterno bianco/interno oro, esterno bianco/interno bianco. Sorgenti luminose a LED con attacco GU10. Downlight ad incasso a tre luci disponibile nelle versioni cromo, oro e bianco con sorgente luminosa a LED con attacco GU5.3.

Collection of suspensions and ceiling lamps with one or three lights in injection moulded white ABS, available in the chrome exterior/white interior, white exterior/gold interior, white exterior/white interior versions. LED light sources with GU10 fitting. Recessed downlight with three lights, available in the chrome, gold and white versions with LED light source and GU5.3 fitting.

Kollektion von Pendel- und Deckenleuchten, ein- oder dreiflammig. Material bestehend aus Spritzguß-Kunststoff ABS; erhältlich in den Ausführungen: außen chromfarben/innen weiß - außen weiß/innen goldfarben - außen weiß/innen weiß. Pendelleuchten mit Lampenfassung GU10 für LED Retrofitleuchtmittel (nicht inbegriffen). Einbau-Deckenleuchten dreiflammig; erhältlich in den Ausführungen chromfarben, goldfarben und weiß. Lampenfassung GU5.3 für LED Retrofitleuchtmittel (nicht inbegriffen)

Collection de suspensions, plafonniers à une ou trois ampoules en ABS blanc moulé à injection, disponibles en version extérieur chromé/intérieur blanc, extérieur blanc/intérieur doré, extérieur blanc/intérieur blanc. Ampoules LED à culot GU10. Downlight encastrable à trois ampoules disponible en version chrome, dorée et blanche, avec ampoule LED à culot GU5.3.

Colección de suspensiones y plafones de una o tres luces en ABS blanco de inyección disponibles en las versiones con exterior cromo/interior blanco, exterior blanco/interior oro, exterior blanco/interior blanco. Fuentes luminosas de LED con portalámparas GU10. Downlight empotrable de tres luces disponible en las versiones cromo, oro y blanco con fuente luminosa de LED con portalámparas GU5.3.

Coleção de luminárias, pendentes, arandelas com uma ou três luzes de ABS branco a injeção, disponíveis nas versões exterior cromo/interior branco, exterior branco/interior ouro, exterior branco/interior branco. Fontes luminosas LED com acoplamento GU10. Downlight de embutir com três luzes, disponível nas versões cromo, ouro e branco, com fonte luminosa LED com acoplamento GU5.3.

Коллекция из подвесных светильников, плафонов с одной или тремя лампами, изготовленных из АБС-пластика белого цвета. Светильники представлены в трех вариантах: снаружи хромированный/внутри белый, снаружи белый/внутри золотой, снаружи белый/внутри белый. Светодиодные лампы с цоколем GU10. Точечные светильники с тремя лампами имеются в следующих вариантах: хром, золото и белый со светодиодом и цоколем GU5.3

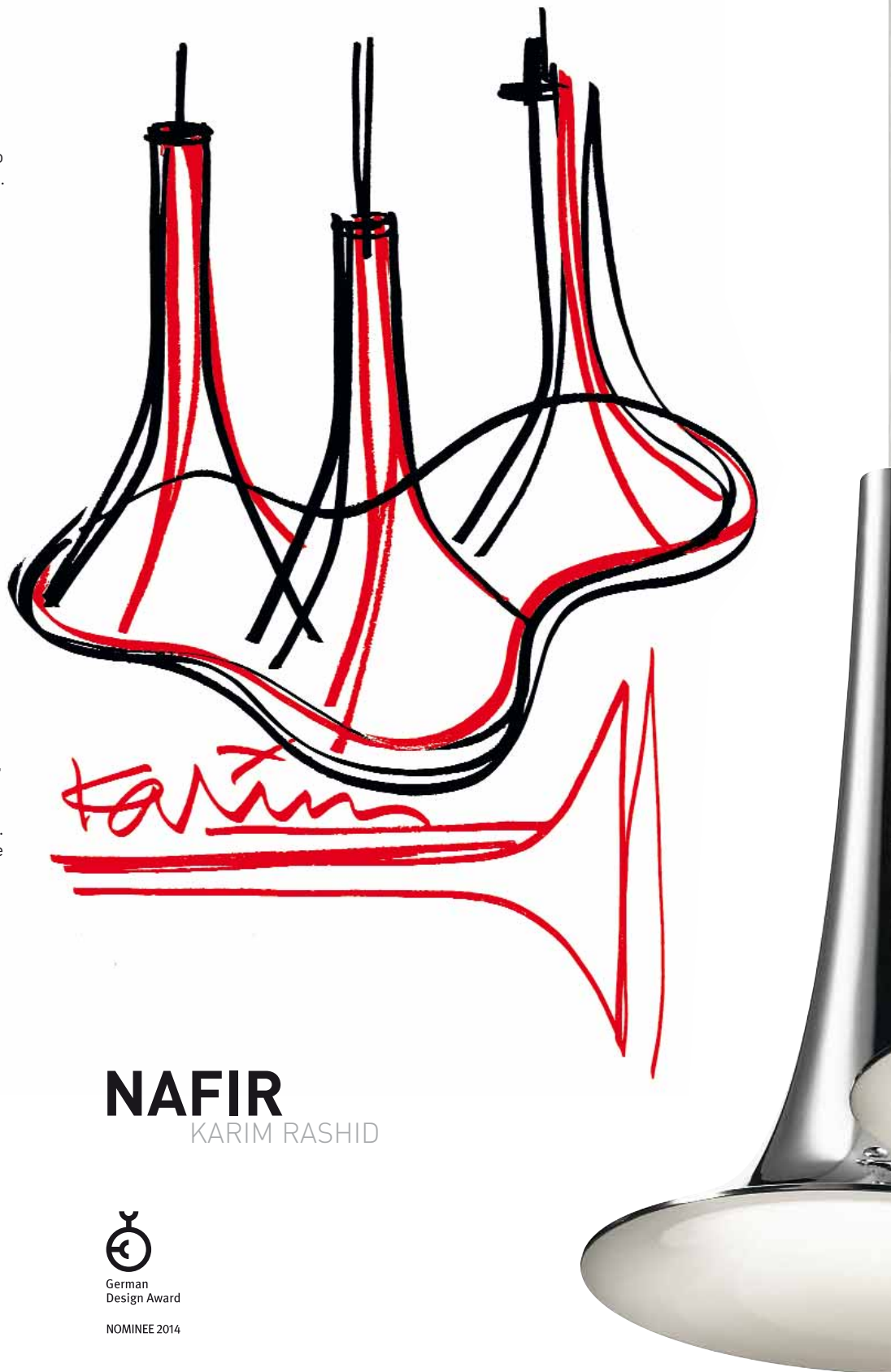

NAFIR

KARIM RASHID



German
Design Award

NOMINEE 2014







^ SP NAFIR 1 CR BC
SP NAFIR 3 CR BC
< SP NAFIR 1 CR BC
<< PG 4-5: SP NAFIR 1 CR BC
SP NAFIR 3 CR BC



^ SP NAFIR 1 BC OR
SP NAFIR 3 BC OR
> SP NAFIR 1 BC OR







^ SP NAFIR 3 BC BC
< SP NAFIR 3 BC BC





- ^ PL NAFIR 1 BC BC
- ^ PL NAFIR 1 BC OR
- > PL NAFIR 3 BC OR
- < PL NAFIR 3 CR BC
- PL NAFIR 1 CR BC













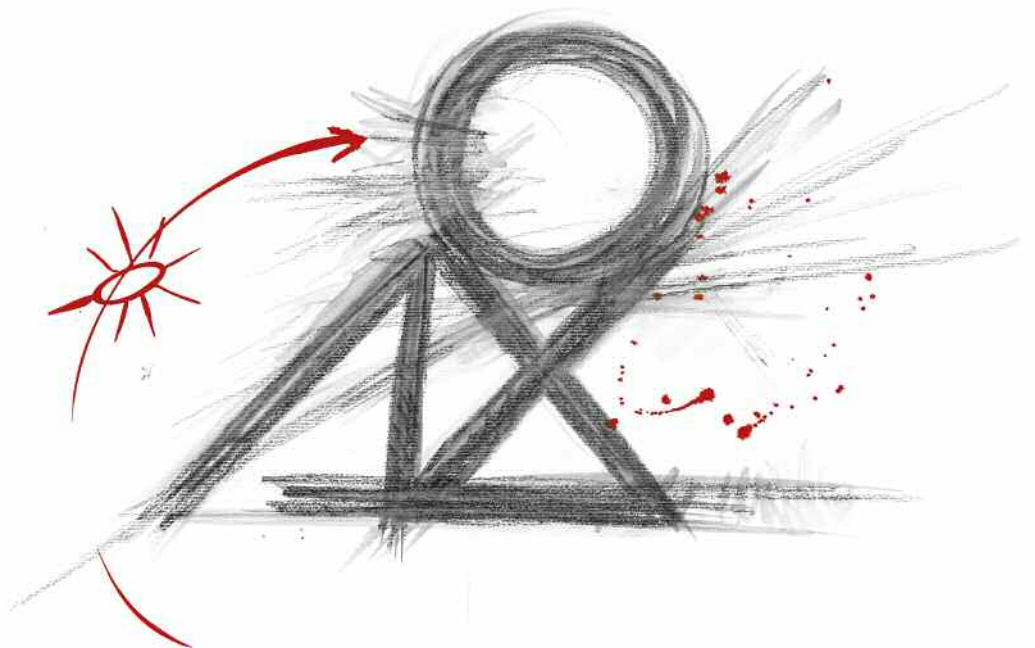





















< PL NAFI 3 | BC CR
PL NAFI 3 | BC OR
PL NAFI 3 | BC BC
> PL NAFI 3 | BC CR





TECHNICAL DATA



-  E27 incandescent
-  E27 incandescent globe
-  E14 incandescent
-  E14 incandescent
-  E27 fluorescent
-  E27 fluorescent globe
-  E27 fluorescent twist
-  E14 fluorescent
-  E14 fluorescent
-  E14 fluorescent
-  E27 fluorescent
-  GX24q-2 fluorescent
-  2GX13 fluorescent
-  2G11 fluorescent
-  G5 fluorescent
-  G24d-2 fluorescent
-  E27 halogen classic
-  E14 halogen classic
-  G9 halogen
-  E27 halogen
-  G4 halogen
-  GY 6.35 halogen
-  GU4 halogen
-  GU5.3 halogen
-  GU10 halogen
-  E14 PAR halogen
-  G53 halogen
-  R7s halogen
-  GU5.3 LED
-  GU10 LED

Verificare dimensioni ed ingombri delle lampadine LED e CFL self ballasted consigliate nel presente catalogo, prima dell'acquisto. Fornitura lampadine LED su richiesta.

Before any purchase, please verify size and dimensions of the LED and CFL self-ballasted bulbs recommended in this catalogue. Supply of LED bulbs on request.

Le schede tecniche dei prodotti Axo Light sono scaricabili direttamente dal nostro sito: www.axolight.it

Axo Light technical sheets can be downloaded directly from our website: www.axolight.it

Die Axo Light Produktdatenblätter können direkt von unserer Website heruntergeladen werden: www.axolight.it

Les fiches techniques des produits Axo Light peuvent être téléchargés directement de notre site: www.axolight.it

Las fichas técnicas de los productos Axo Light se pueden descargar directamente de nuestro sitio web: www.axolight.it

As fichas técnicas dos produtos Axo Light podem ser baixadas diretamente do nosso site: www.axolight.it

Технические характеристики изделий фирмы Axo Light возможно скачать с нашего сайта: www.axolight.it



I nostri prodotti sono tutti sottoposti alle prove di sicurezza elettrica e conformi alle Direttive Comunitarie Europee EN60598-1, LVD 2006/95/EC, EMC 2004/108/EC, IEC 62471 (ove previsto).

All our products undergo electric safety tests and comply with ECC Directive EN60598-1, LVD 2006/95/EC, EMC 2004/108/EC, IEC 62471 (where provided).

Entsprechend den Europäischen Normen EN60598-1, LVD 2006/95/EC, EMC 2004/108/EC, IEC 62471 (sofern vorgesehen), werden alle Produkte den elektrischen Sicherheitsprüfungen unterzogen.

Tous nos produits sont soumis aux tests de sécurité, et sont conformes aux Directives CEE EN60598-1, LVD 2006/95/EC, EMC 2004/108/EC, IEC 62471 (le cas échéant).

Todos nuestros productos han sido sometidos a las pruebas de seguridad eléctrica y son conformes con las directivas comunitarias europeas EN60598-1, LVD 2006/95/EC, EMC 2004/108/EC, IEC 62471 (en los casos previstos).

Os nossos produtos são todos submetidos aos testes de segurança elétrica e conformes às Diretivas Comunitárias Europeias EN60598-1, LVD 2006/95/EC, EMC 2004/108/EC, IEC 62471 (se previsto).

Все наши изделия проходят испытания на электрическую безопасность и соответствуют директивам Европейского Сообщества EN60598-1, LVD 2006/95/EC, EMC 2004/108/EC, IEC 62471 (в случаях, когда это предусмотрено).



Solo isolamento fondamentale; le parti conduttrici accessibili sono collegate ad un conduttore di terra. Messa a terra obbligatoria.

Basic insulation, accessible conductors are earthed. Earthing is compulsory.

Grundisolation: berührbare Metallteile mit Anschlussstelle für Schutzleiter verbunden. Netzschutzleiter: vorgeschrieben.

Isolation de base: les parties conductrices accessibles sont mises à terre. Mise à terre obligatoire.

Solo aislamiento fundamental; las partes conductoras accesibles están conectadas a un conductor de tierra. Puesta a tierra obligatoria.

Somente isolamento fundamental; as partes condutoras acessíveis são conectadas em um condutor de terra. Aterramento obrigatório.

“Изоляция только базовая. Доступные проводниковые части подсоединены к заземлителю. Заземление обязательно.



Sistema a doppio isolamento; messa a terra esclusa.

Double insulation. Earthing: excluded.

Doppelte Isolierung. Netzschutzleiter: nicht erlaubt.

Double isolation. Mise à la terre: exclue.

Sistema de doble aislamiento; puesta a tierra no incluida.

Sistema com isolamento duplo; aterramento excluído.

Система двойной изоляции. Заземление исключено.



Apparecchio in cui la protezione contro la scossa elettrica si basa sulla alimentazione a bassissima tensione di sicurezza.

Appliance in which protection against electrical shock is guaranteed by the extremely low-voltage power supply.

Zum Schutz vor elektrischen Schlägen mit Niedervolt gespeistes Gerät.

Appareil avec protection contre les décharges életriques basée sur l'alimentation à une tension de sécurité très basse.

Aparato en el cual la protección contra la descarga eléctrica se debe a la alimentación a muy baja tensión.

Aparelho no qual a proteção contra choque elétrico baseia-se na alimentação com baixíssima tensão de segurança.

Прибор, в котором защита от удара током основана на питании от очень низкого напряжения.

IPXY

Grado di protezione contro corpi solidi X – e contro i liquidi Y.

Protection rating against solid bodies X – against liquids Y.

Schutzgrad X gegen feste Körper – Schutzgrad Y gegen Flüssigkeiten.

Niveau de protection contre corps solides X – et contre les liquides Y.

Grado de protección contra cuerpos sólidos X – y contra los líquidos Y.

Grau de proteção contra corpos sólidos X – e contra os líquidos Y.

Степень защиты от проникновения твердых тел X и жидкостей Y.



Predisposto con variatore di luce.

With dimmer.

Mit Dimmer.

Avec dimmer.

Con dimmer.

Predisposto com variador de luz.

Предусмотрено с диммер.



Dimmerabile solo con driver dedicato.

Dimmable only with dedicated power supply unit.

Nur mit dem vorgesehenen Treiber dimmbar.

Dimmerable uniquement avec driver spécifique.

Regulable sólo con driver específico.

Atenuável somente com unidade de abastecimento de potência dedicada.

Регулировка яркости возможна только со специальным блоком питания.



Articolo dimmerabile 1-10V.

Dimmable 1-10V.

Article pouvant être muni d'un variateur de lumière 1-10V.





Dimmbare Ausführung 1–10 V.





Artículo dimmerable 1-10V.

Artigo regulável dimmer 1-10V.

регулятор яркости 1-10В.

LT MUSE G

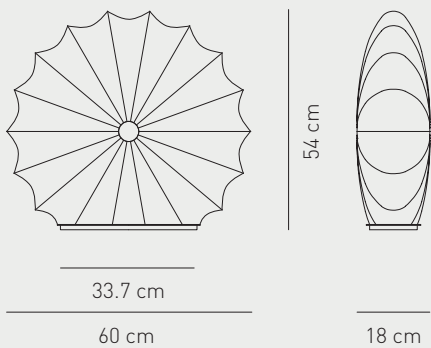

base / bulb type E27 halogen
power 1 x max 105 W
ilcos HSGSA/UB 
marks    IP20

base / bulb type E27 fluorescent
power 1 x max 20 W
ilcos FB-CFL (dim. only) 
marks    IP20



NAFIR WHITE VARNISHED OR GOLDEN FITTINGS



PL NAFIR 1

base / bulb type GU10 LED bulbs
power 1 x max 7.5 W
ilcos DRPAR LED 
marks   IP20

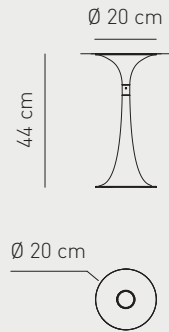
the total height of the bulbs must be between 52 and 62 mm





PL NAFIR 3

base / bulb type GU10 LED bulbs
power 3 x max 7.5 W
ilcos DRPAR LED 
marks   IP20

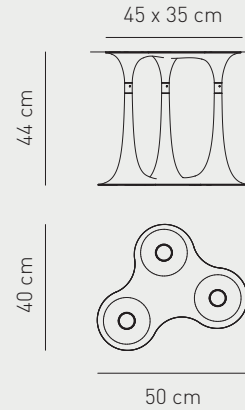
the total height of the bulbs must be between 52 and 62 mm





PL NAFI 3 I (recessed trimless downlights)

base / bulb type GU5.3 LED bulbs
power 3 x max 5 W
ilcos DRR LED 
marks   12V IP20

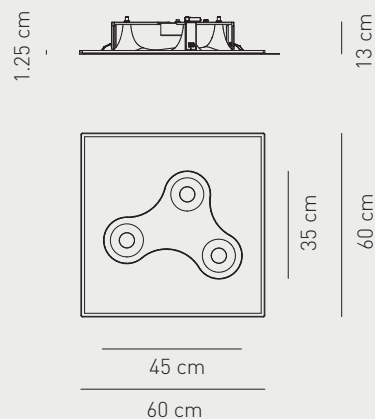
min depth 15 cm (standard ceiling) / 40 cm (false ceiling tiles). The total height of the bulbs must be between 40 and 55 mm





SP NAFIR 1

base / bulb type GU10 LED bulbs
power 1 x max 7.5 W
ilcos DRPAR LED 
marks   IP20

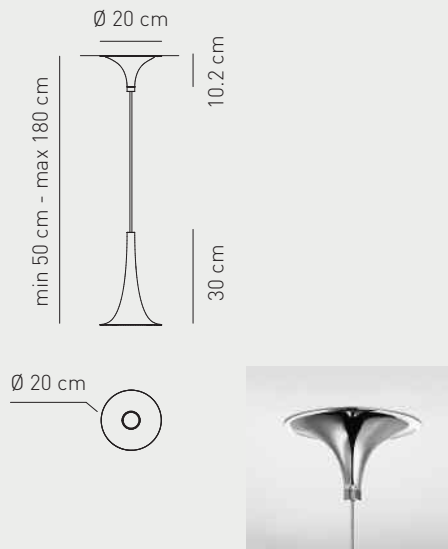
the total height of the bulbs must be between 52 and 62 mm



SP NAFIR 3

base / bulb type GU10 LED bulbs
power 3 x max 7.5 W
ilcos DRPAR LED 
marks   IP20

the total height of the bulbs must be between 52 and 62 mm

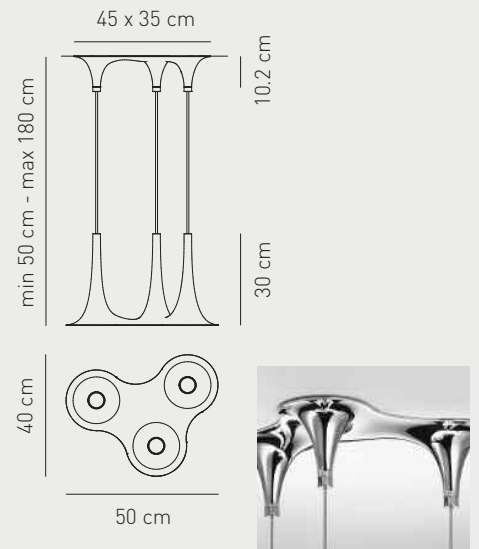

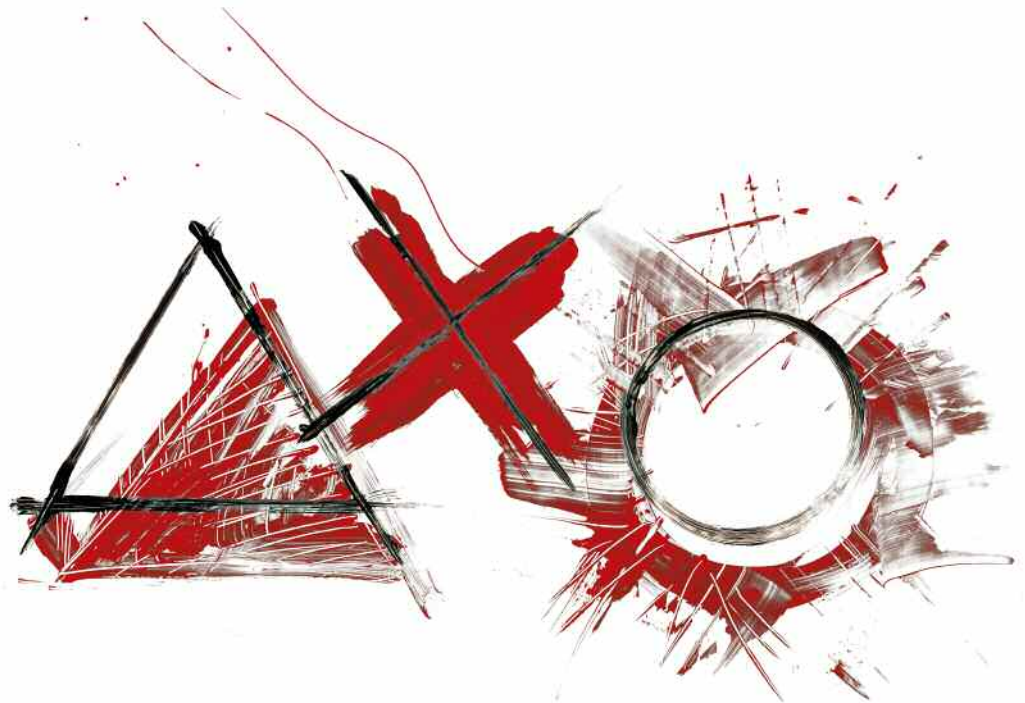

Axo Light si riserva il diritto di apportare ai modelli, senza alcun preavviso, qualsiasi modifica ritenesse opportuna. Axo Light non risponde per eventuali danni a persone o cose causati da una non corretta installazione dei propri apparecchi d'illuminazione. I dati riportati sono puramente indicativi; è possibile che siano riportati degli errori di stampa.

Axo Light reserves itself the right to introduce any changes to its own models, without prior notice. Axo Light is not liable for injuries or damage due to the incorrect installation of its fixtures. The details given here are intended purely as guidance as errors may have occurred during the printing process.

Axo Light behält sich das Recht vor, jederzeit und ohne Voranmeldung, Änderungen der Kollektion vorzunehmen, ohne jedoch die charakteristischen Eigenschaften der Artikel zu ändern. Axo Light ist nicht verantwortlich für eventuelle Personen -oder Sachschäden, verursacht durch unsachgemäße Installation der Produkte. Aufgrund möglicher Druckfehler, sind die angegebenen Daten lediglich als Richtwerte zu verstehen.

Axo Light se réserve le droit de modifier ses collections à tous moments et sans préavis, dans le respect des caractéristiques de base du produit. Axo Light ne répond pas aux éventuels dommages à personnes ou choses causés par une mauvaise installation de ses appareils d'éclairage. Les coordonnées mentionnées sont purement indicatives; il est possible que des erreurs d'impression y figurent.

Axo Light se reserva el derecho de aportar a los propios modelos, sin ningún preaviso, cualquier modificación que se considere oportuna. Axo Light no responde por los eventuales daños causados a personas o cosas provocados por una incorrecta instalación de los propios aparatos de iluminación. Los datos que aparecen son puramente indicativos; es posible que contengan errores de impresión.

Axo Light reserva-se o direito de efetuar nos modelos, sem nenhum pré-aviso, qualquer modificação que considerar oportuna. Axo Light não responde por eventuais danos a pessoas ou coisas causados por uma instalação incorreta dos próprios aparelhos de iluminação. Os dados reproduzidos são meramente indicativos; é possível que estejam indicados erros de impressão.

Axo Light оставляет за собой право вносить модификации моделей без предупреждения, в случае необходимости. Axo Light не несёт ответственности за ущерб людям или вещам, вызванный некорректной установкой осветительных приборов. Приведенные данные носят иллюстративный характер; возможны опечатки.