

ABALLS AII ME - ABALLS AII GR

by Jaime Hayón, 2016

Ceiling lamp. Base in white, black, golden, copper or platinum ceramic. Diffuser in blown opal matt glass.

Lámpara de techo. Base de cerámica acabada en blanco, negro, dorado, cobre o platino. Difusor de cristal soplado opal mate.

Type: Ceiling lamp

Tipo: Lámpara de techo

Environment: Indoor

Ámbito de utilización: Interior

Structure: Ceramic

Estructura: Cerámica

Diffuser: Glass

Difusor: Cristal

Voltage

Voltaje: 230 V

Supply: Terminal strip

Alimentación: Regleta

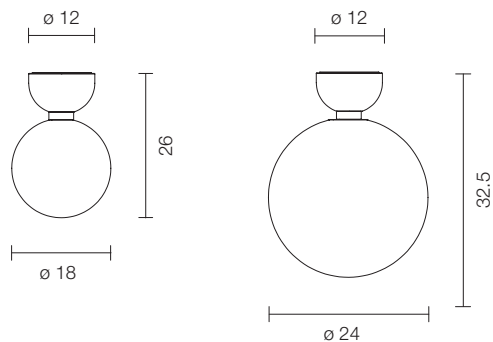

Light Source

Fuente de luz: G9 - Max 48 W 





ABALLS AII ME



408000500005 **white** / blanco
408000500006 **black** / negro
408000500007 **golden** / dorado
408000500008 **copper** / cobre
408000500028 **platinum** / platino

 1.5 kg
 0.0 kg

ABALLS AII GR

409000500005 **white** / blanco
409000500006 **black** / negro
409000500007 **golden** / dorado
409000500008 **copper** / cobre
409000500028 **platinum** / platino

 1.5 kg
 0.0 kg

CE    IP-20