



MUSE

SANDRO SANTANTONIO

Collezione di lampade con struttura metallica bianca e rivestimento in tessuto elasticizzato, sfoderabile e lavabile. Varie misure disponibili. Questi articoli ampliano l'offerta della collezione Muse già presente nel catalogo generale 2011-2012.

Collection of lamps with white metal frame and removable and washable elastic fabric covering. Various sizes available. These items extend the existing range of the Muse collection featured in the 2011-2012 general catalogue.

Leuchtenkollektion mit weißer Metall-Struktur und elastischem, abziehbaren und waschbaren Stoff. Es stehen verschiedene Größen zur Auswahl. Diese Artikel ergänzen das Angebot der Kollektion Muse aus dem Gesamtkatalog 2011-2012.

Collection de lampes avec structure métallique blanche et revêtement en tissu élastique, amovible et lavable. Plusieurs dimensions disponibles. Ces articles complètent l'offre de la collection Muse qui est déjà publiée sur le catalogue général 2011-2012.

Colección de lámparas con estructura metálica blanca y revestimiento en tejido elasticado, desfundable y lavable. Se encuentran disponibles varias medidas. Estos artículos amplían la oferta de la colección Muse ya presente en el catálogo general 2011-2012.

Коллекция светильников с белым металлическим каркасом и съемным моющимся абажуром из эластичной ткани. Предлагаются различные размеры. Эти изделия дополняют коллекцию Muse, уже присутствующую в общем каталоге 2011-2012.







< SP MUSE 25
« PG 45: LT MUSE G / SP MUSE 60

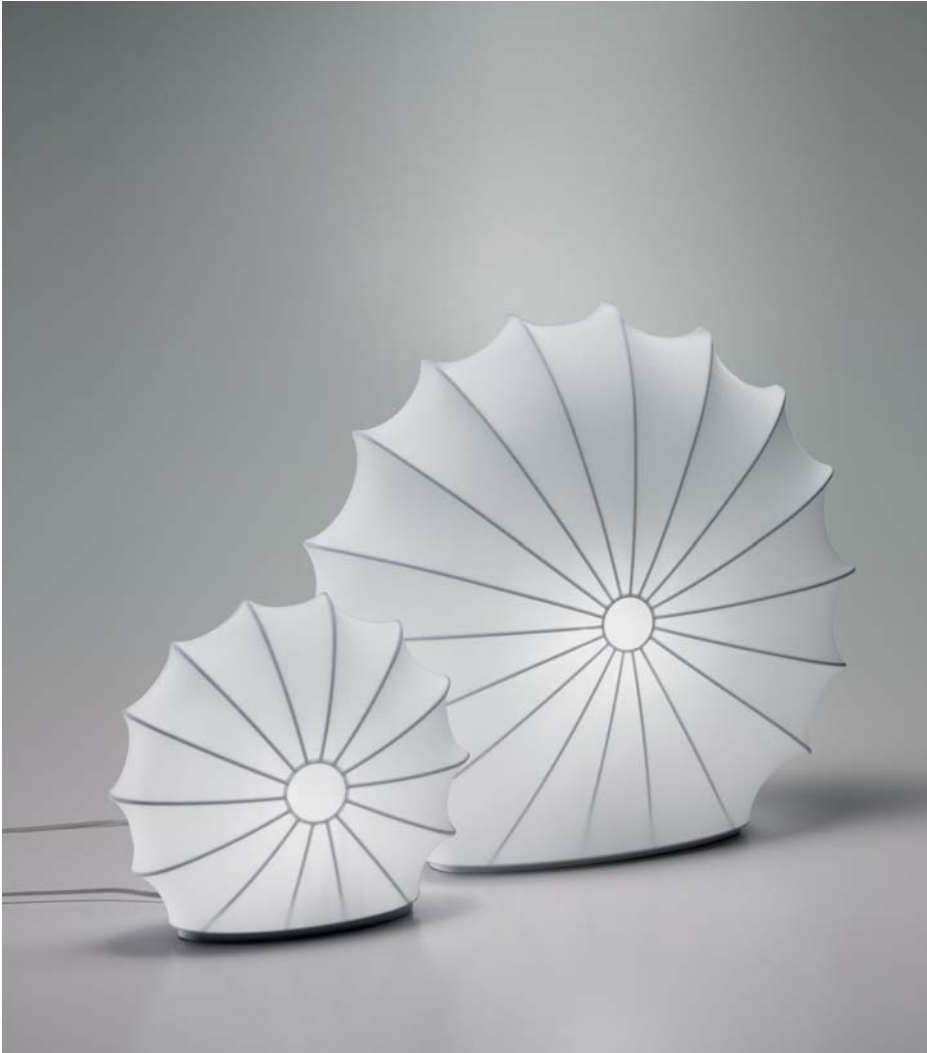

^ LT MUSE P / LT MUSE G
> LT MUSE P / PL MUS 60 Q





< PL MU 120 Q / PL MUS 60 Q





^ PL MUSE 80 FI (FLOWER)
< PL MUSE 40 ST / PL MUS 120 ST (STICKS)





< PL MUSE 40 FI / PL MUSE 60 FI
PL MUSE 80 FI / PL MUS 120 FI
(FLOWER)



Designpreis
Deutschland
2011

NOMINEE



MUSE MULTICOLOR

AS AWARDED BY THE CHICAGO ATHENAEUM:

MUSEUM OF ARCHITECTURE AND DESIGN.

IN THE PERMANENT DESIGN COLLECTION OF THE CHICAGO

ATHENAEUM: MUSEUM OF ARCHITECTURE AND DESIGN.



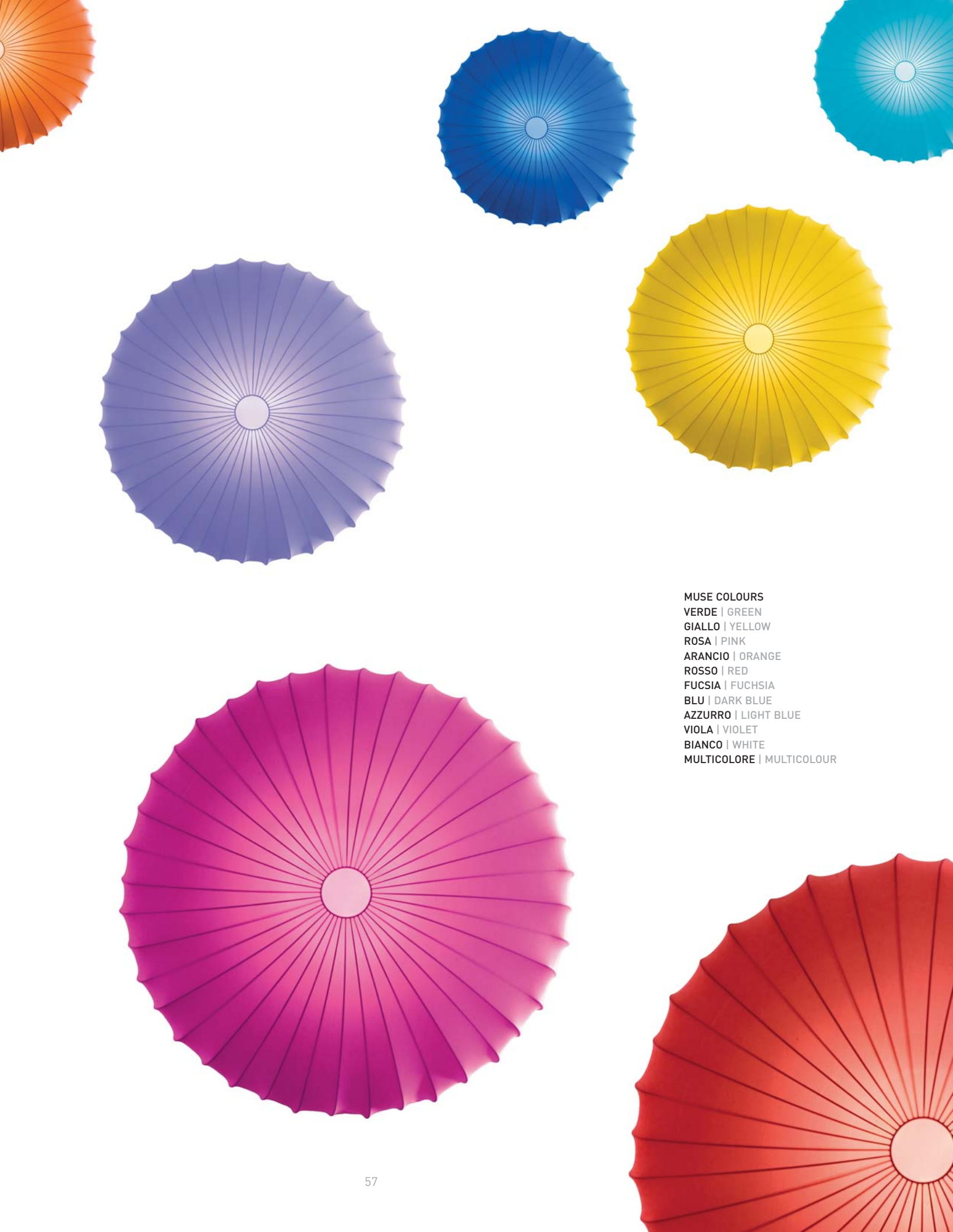

MUSE COLOURS
VERDE | GREEN
GIALLO | YELLOW
ROSA | PINK
ARANCIO | ORANGE
ROSSO | RED
FUCSIA | FUCHSIA
BLU | DARK BLUE
AZZURRO | LIGHT BLUE
VIOLA | VIOLET
BIANCO | WHITE
MULTICOLORE | MULTICOLOUR

TECHNICAL DATA

70	EXPLO
71	MUSE
76	SHARAV
76	SPILLRAY
79	SUNSHADE

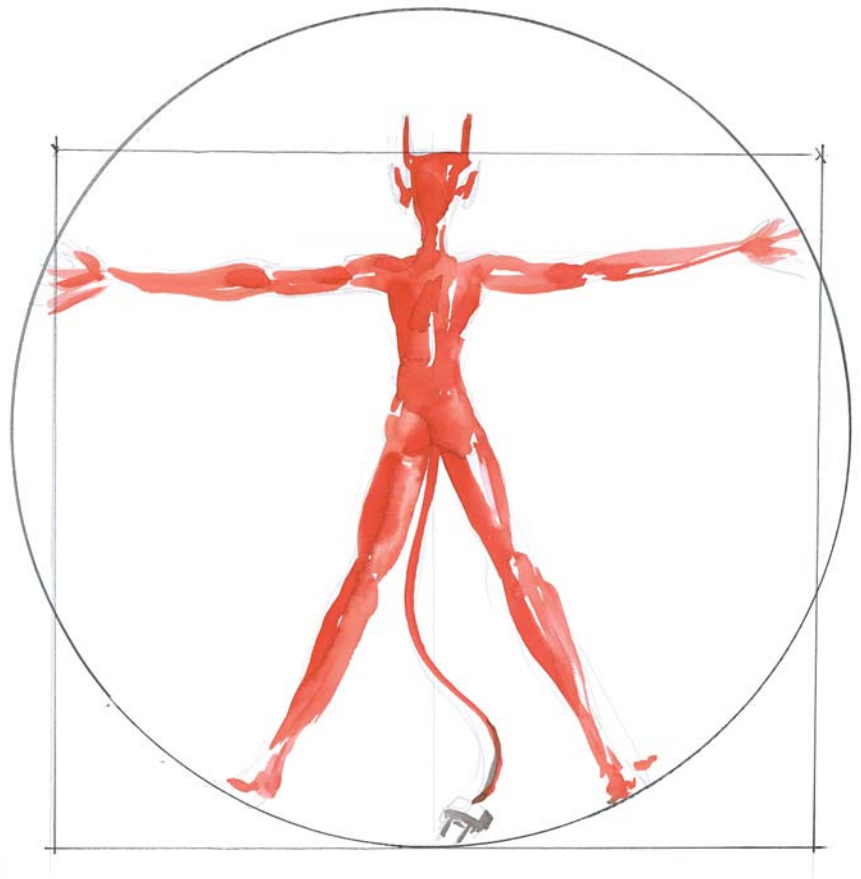

Axo Light si riserva il diritto di apportare ai modelli, senza alcun preavviso, qualsiasi modifica ritenesse opportuna. Axo Light non risponde per eventuali danni a persone o cose causati da una non corretta installazione dei propri apparecchi d'illuminazione.

I dati riportati sono puramente indicativi; è possibile che siano riportati degli errori di stampa.











Axo Light reserves itself the right to introduce any changes to its own models, without prior notice. Axo Light is not liable for injuries or damage due to the incorrect installation of its fixtures. The details given here are intended purely as guidance as errors may have occurred during the printing process.

Axo Light behält sich das Recht vor, jederzeit und ohne Voranmeldung, Änderungen der Kollektion vorzunehmen, ohne jedoch die charakteristischen Eigenschaften der Artikel zu ändern. Axo Light ist nicht verantwortlich für eventuelle Personen -oder Sachschäden, verursacht durch unsachgemäße Installation der Produkte. Aufgrund möglicher Druckfehler, sind die angegebenen Daten lediglich als Richtwerte zu verstehen.

Axo Light se réserve le droit de modifier ses collections à tous moments et sans préavis, dans le respect des caractéristiques de base du produit. Axo Light ne répond pas aux éventuels dommages à personnes ou choses causés par une mauvaise installation de ses appareils d'éclairage. Les coordonnées mentionnées sont purement indicatives; il est possible que des erreurs d'impression y figurent.

Axo Light se reserva el derecho de aportar a los propios modelos, sin ningún preaviso, cualquier modificación que se considere oportuna. Axo Light no responde por los eventuales daños causados a personas o cosas provocados por una incorrecta instalación de los propios aparatos de iluminación. Los datos que aparecen son puramente indicativos; es posible que contengan errores de impresión.

Ахо Light оставляет за собой право вносить модификации моделей без предупреждения, в случае необходимости. Ахо Light не несёт ответственности за ущерб людям или вещам, вызванный некорректной установкой осветительных приборов. Приведенные данные носят иллюстративный характер; возможны опечатки.

-  E27 incandescent
-  E27 fluorescent
-  E27 fluorescent globe
-  E14 fluorescent
-  2GX13 fluorescent
-  E27 halogen classic
-  E14 halogen classic
-  E27 halogen
-  G4 halogen
-  GU10 halogen / led
-  R7s halogen

Nota

Per tutte le lampadine CFL self ballasted consigliate nel presente catalogo, è preferibile verificarne dimensioni ed ingombri prima dell'acquisto

Note

Before any purchase, please verify size and dimensions of the CFL self-ballasted bulbs recommended in this catalogue.



I nostri prodotti sono tutti sottoposti alle prove di sicurezza elettrica e conformi alle Direttive Comunitarie Europee EN60598-1, LVD 2006/95/EC, EMC 2004/108/EC (ove previsto).

All our products undergo electric safety tests and comply with ECC Directive EN60598-1, LVD 2006/95/EC, EMC 2004/108/EC (where provided).

Entsprechend den Europäischen Normen EN60598-1, LVD 2006/95/EC, EMC 2004/108/EC (sofern vorgesehen), werden alle Produkte den elektrischen Sicherheitsprüfungen unterzogen.

Tous nos produits sont soumis aux tests de sécurité, et sont conformes aux Directives CEE EN60598-1, LVD 2006/95/EC, EMC 2004/108/EC (le cas échéant).

Todos nuestros productos han sido sometidos a las pruebas de seguridad eléctrica y son conformes con las directivas comunitarias europeas EN60598-1, LVD 2006/95/EC, EMC 2004/108/EC (en los casos previstos).

Все наши изделия проходят испытания на электрическую безопасность и соответствуют директивам Европейского Сообщества EN60598-1, LVD 2006/95/EC, EMC 2004/108/EC (в случаях, когда это предусмотрено).



Solo isolamento fondamentale; le parti conduttrici accessibili sono collegate ad un conduttore di terra. Messa a terra obbligatoria.

Basic insulation, accessible conductors are earthed. Earthing is compulsory.

Grundisolation: berührbare Metallteile mit Anschlussstelle für Schutzleiter verbunden. Netzschutzleiter: vorgeschrieben.

Isolation de base: les parties conductrices accessibles sont mises à terre. Mise à terre obligatoire.

Solo aislamiento fundamental; las partes conductoras accesibles están conectadas a un conductor de tierra. Puesta a tierra obligatoria.

Изоляция только базовая. Доступные проводниковые части подсоединены к заземлителю. Заземление обязательно.



Sistema a doppio isolamento; messa a terra esclusa.

Double insulation. Earthing: excluded.

Doppelte Isolierung. Netzschutzleiter: nicht erlaubt.

Double isolation. Mise à la terre: exclue.

Sistema de doble aislamiento; puesta a tierra no incluida.

Система двойной изоляции. Заземление исключено.



Apparechio in cui la protezione contro la scossa elettrica si basa sulla alimentazione a bassissima tensione di sicurezza.

Appliance in which protection against electrical shock is guaranteed by the extremely low-voltage power supply.

Zum Schutz vor elektrischen Schlägen mit Niedervolt Gespeistes Gerät.

Appareil avec protection contre les décharges életriques basée sur l'alimentation à une tension de sécurité très basse.

Aparato en el cual la protección contra la descarga eléctrica se debe a la alimentación a muy baja tensión.

Прибор, в котором защита от удара током основана на питании от очень низкого напряжения.



Predisposto con variatore di luce.

With dimmer.

Mit Dimmer.

Avec dimmer.

Con dimmer.

Предусмотрено с диммер.

IP20

Grado di protezione contro la penetrazione di polvere, corpi solidi e umidità.

Protection against dust, solid objects and humidity penetration.

Schutzgrad gegen Staubeinwirkung, feste Bestandteile und Feuchtigkeit.

Degré de protection contre la pénétration de poudre, corps solides et humidité.

Grado de protección contra la penetración de polvo, cuerpos sólidos y humedad.

Степень защиты от проникновения пыли, инородных тел и влаги.

Le schede tecniche dei prodotti Axo Light sono scaricabili direttamente dal nostro sito.

Axo Light technical sheets can be downloaded directly from our website.



Les fiches techniques des produits Axo Light peuvent être téléchargés directement de notre site.

Las fichas técnicas de los productos Axo Light se pueden descargar directamente de nuestro sitio web.

Die Axo Light Produktdatenblätter können direkt von unserer Website heruntergeladen werden.

Технические характеристики изделий фирмы Axo Light возможно скачать с нашего сайта.



SP EXPL 10

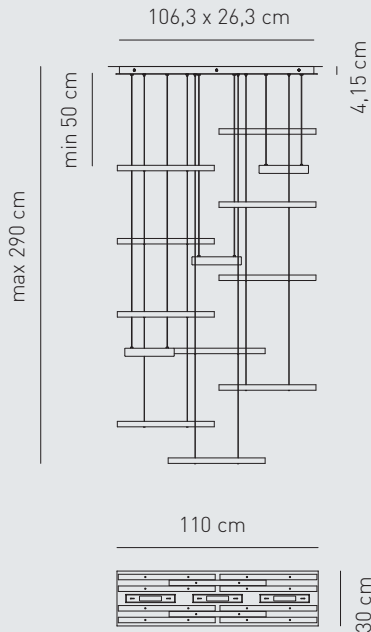

base / bulb type	R7s halogen
power	3 x max 120 W (118mm)
ilcos	HDG 
marks	CE  IP20





MUSE WHITE VARNISHED FITTINGS

PL MUS 60 Q

base / bulb type	E27 incandescent
power	2 x max 60 W
ilcos	IAA/C 
marks	CE  IP20



base / bulb type	E27 halogen
power	2 x max 42 W
ilcos	HSGSA/UB 
marks	CE  IP20

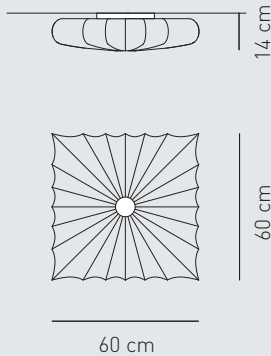

base / bulb type	E27 fluorescent
power	2 x max 13 W
ilcos	FB-CFL 
marks	CE  IP20



application: both as ceiling or wall lamp





PL MU 120 Q

base / bulb type	E27 incandescent
power	3 x max 100 W
ilcos	IAA/C 
marks	CE  IP20

base / bulb type	E27 halogen
power	3 x max 70 W
ilcos	HSGSA/UB 
marks	CE  IP20



base / bulb type	E27 fluorescent
power	3 x max 23 W
ilcos	FB-CFL 
marks	CE  IP20

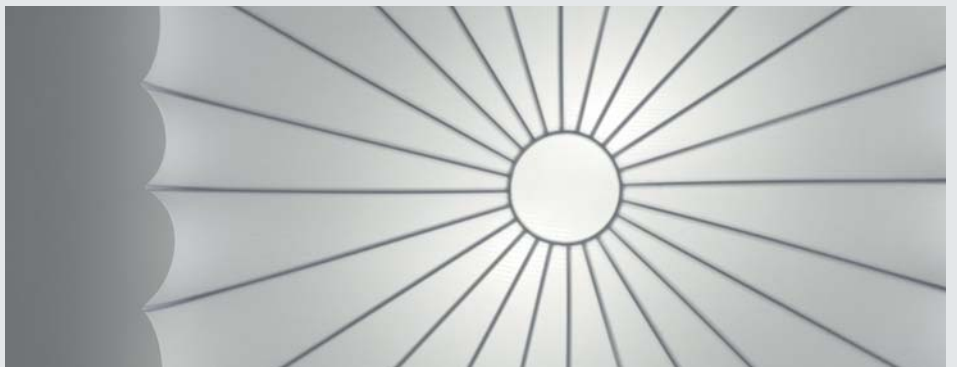
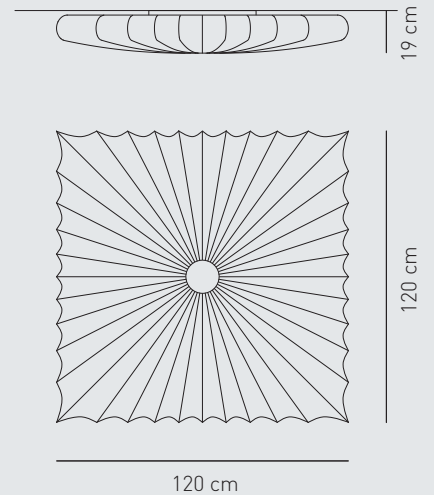

base / bulb type	2GX13
power	1 x 55 W
ilcos	FC 
marks	CE  IP20

application: both as ceiling or wall lamp





LT MUSE P

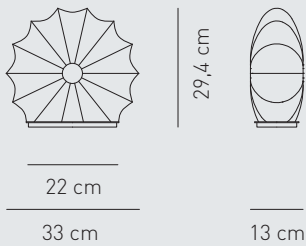

base / bulb type E14 halogen
power 1 x max 42 W
ilcos HSGSP/UB 
marks   IP20

base / bulb type E14 fluorescent
power 1 x max 10 W
ilcos FB-CFL 
marks   IP20





LT MUSE G

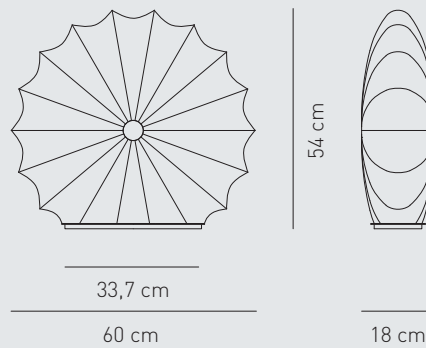

base / bulb type E27 halogen
power 1 x max 105 W
ilcos HSGSA/UB 
marks   IP20

base / bulb type E27 fluorescent
power 1 x max 20 W
ilcos FB-CFL (dim. only) 
marks   IP20





SP MUSE 25

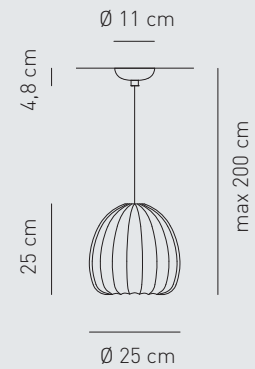

base / bulb type E14 halogen
power 1 x max 42 W
ilcos HSGSP/UB 
marks   IP20

base / bulb type E14 fluorescent
power 1 x max 10 W
ilcos FB-CFL 
marks   IP20



SP MUSE 60



base / bulb type E27 halogen
power 3 x max 105 W
ilcos HSGSA/UB 
marks CE  IP20

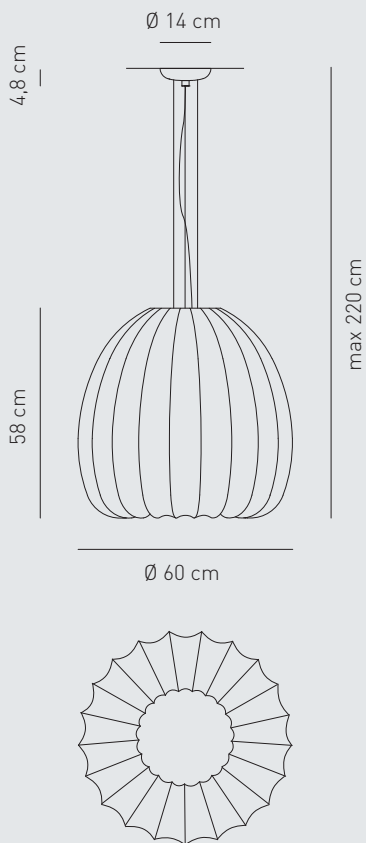

base / bulb type E27 fluorescent
power 3 x max 33 W
ilcos FB-CFL 
marks CE  IP20





MUSE FIORE

PL MUSE 40 FI

base / bulb type E27 incandescent
power 1 x max 60 W
ilcos IAA/C 
marks CE  IP20



base / bulb type E27 halogen
power 1 x max 42 W
ilcos HSGSA/UB 
marks CE  IP20

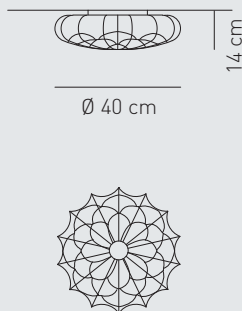

base / bulb type E27 fluorescent
power 1 x max 13 W
ilcos FB-CFL 
marks CE  IP20



application: both as ceiling or wall lamp



PL MUSE 60 FI

base / bulb type E27 incandescent
power 2 x max 60 W
ilcos IAA/C 
marks CE  IP20



base / bulb type E27 halogen
power 2 x max 42 W
ilcos HSGSA/UB 
marks CE  IP20

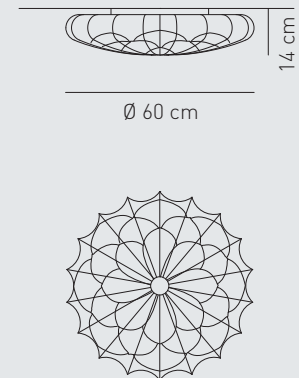

base / bulb type E27 fluorescent
power 2 x max 13 W
ilcos FB-CFL 
marks CE  IP20



application: both as ceiling or wall lamp





PL MUSE 80 FI

base / bulb type E27 incandescent
power 3 x max 100 W
ilcos IAA/C 
marks  

base / bulb type E27 halogen
power 3 x max 70 W
ilcos HSGSA/UB 
marks  



base / bulb type E27 fluorescent
power 3 x max 23 W
ilcos FB-CFL 
marks  

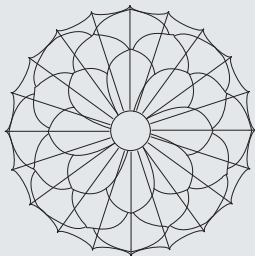
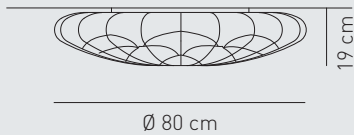

base / bulb type 2GX13
power 1 x 55 W
ilcos FC 
marks  



application: both as ceiling or wall lamp



PL MUS 120 FI

base / bulb type E27 incandescent
power 3 x max 100 W
ilcos IAA/C 
marks  

base / bulb type E27 halogen
power 3 x max 70 W
ilcos HSGSA/UB 
marks  

base / bulb type E27 fluorescent
power 3 x max 23 W
ilcos FB-CFL 
marks  



base / bulb type 2GX13
power 1 x 55 W
ilcos FC 
marks  

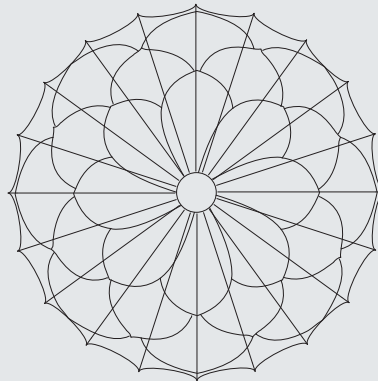
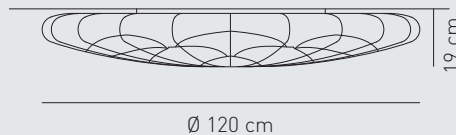

application: both as ceiling or wall lamp





MUSE STICKS

PL MUSE 40 ST

base / bulb type E27 incandescent
power 1 x max 60 W
ilcos IAA/C 
marks  



base / bulb type E27 halogen
power 1 x max 42 W
ilcos HSGSA/UB 
marks  

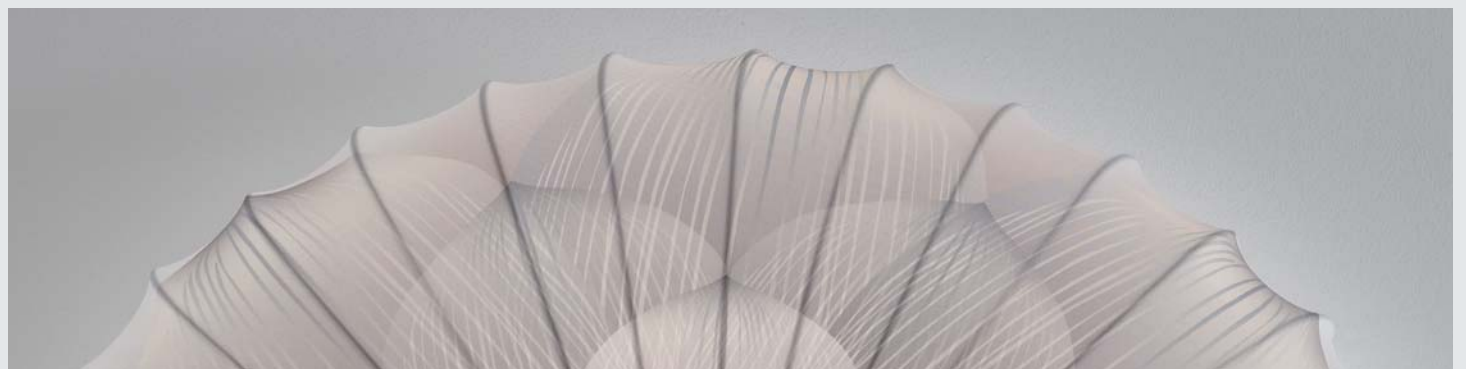
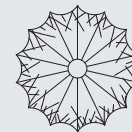
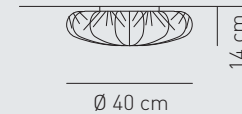

base / bulb type E27 fluorescent
power 1 x max 13 W
ilcos FB-CFL 
marks  



application: both as ceiling or wall lamp



PL MUSE 60 ST



base / bulb type E27 incandescent
power 2 x max 60 W
ilcos IAA/C 
marks   IP20



base / bulb type E27 halogen
power 2 x max 42 W
ilcos HSGSA/UB 
marks   IP20



base / bulb type E27 fluorescent
power 2 x max 13 W
ilcos FB-CFL 
marks   IP20



application: both as ceiling or wall lamp

PL MUSE 80 ST

base / bulb type E27 incandescent
power 3 x max 100 W
ilcos IAA/C 
marks   IP20



base / bulb type E27 halogen
power 3 x max 70 W
ilcos HSGSA/UB 
marks   IP20



base / bulb type E27 fluorescent
power 3 x max 23 W
ilcos FB-CFL 
marks   IP20



base / bulb type 2GX13
power 1 x 55 W
ilcos FC 
marks   IP20



application: both as ceiling or wall lamp

PL MUS 120 ST

base / bulb type E27 incandescent
power 3 x max 100 W
ilcos IAA/C 
marks   IP20

base / bulb type E27 halogen
power 3 x max 70 W
ilcos HSGSA/UB 
marks   IP20

base / bulb type E27 fluorescent
power 3 x max 23 W
ilcos FB-CFL 
marks   IP20

base / bulb type 2GX13
power 1 x 55 W
ilcos FC 
marks   IP20

application: both as ceiling or wall lamp

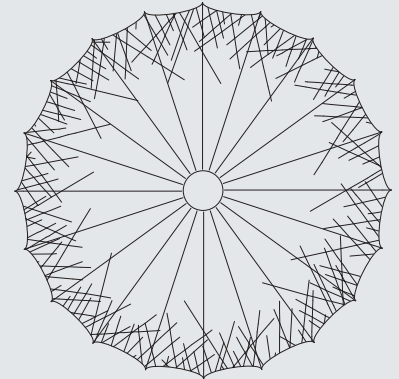
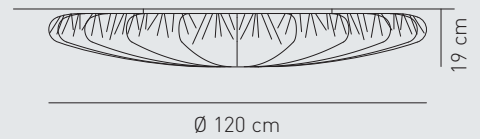
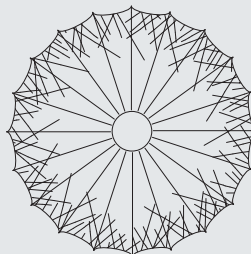
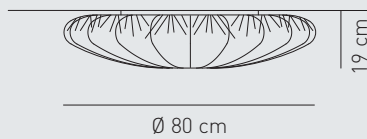
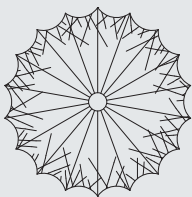
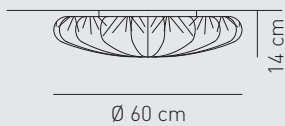

AXOLIGHT NEWS 2012-1

Art director

Lorenzo Truant

Graphic design

+ fortuna

Paola Fortuna with Peppe Clemente

Artworks by Tullio Sila

Coordination and editing

Fabrizio Cettina

Photo credits

Florindo Romandini

Photolitho

Fotolito Quattrifoglio

Printed

Control-K Padova

